

FORD

TRACTOR

SERIES 600 AND 800

OWNER'S
MANUAL



TRACTOR AND IMPLEMENT DIVISION
FORD MOTOR COMPANY

Ford Farming

**GETS MORE DONE
...AT LOWER COST**



FORD TRACTOR

SERIES 600 AND 800

OWNER'S MANUAL

Copyright 1954

Ford Motor Company

Dearborn, Michigan

All Rights Reserved

"Reproduced under license agreement
with Ford Motor Company."
License # 5001 3-1-94

Prepared by

TRACTOR AND IMPLEMENT DIVISION
FORD MOTOR COMPANY
BIRMINGHAM, MICHIGAN

Tractor Service Policy

Ford
TRACTOR

SERVICE POLICY

OWNER'S NAME _____

MAILING ADDRESS _____

CITY _____ STATE _____

TRACTOR MODEL _____

SERIAL NUMBER _____

DELIVERY DATE _____

ISSUED BY:

FORD TRACTOR AND IMPLEMENT DEALER _____

CITY _____ STATE _____

DEALER'S SIGNATURE _____

At the time of delivery of your new tractor, the Ford Tractor and Implement Dealer presented to you a copy of the Service Policy shown above. This policy certifies that your new Ford Tractor has been properly inspected and prepared for delivery by the dealer.

The policy should be presented to the dealer whenever you request any service which is authorized on it. We recommend, therefore, that you keep the policy in a safe place for ready reference at all times.

FOREWORD

We wish to congratulate you on your choice of the new Ford Tractor. We are happy to have you as a customer and are confident that you will receive unequalled performance from your Ford Tractor.

This manual has been prepared to acquaint you with the many features of your new Ford Tractor. Due to the selection of engines, transmissions, clutches and axles available with the new Ford Tractors, most of the information presented here is general and applies to both Series 600 and 800 tractors. Where differences exist, specific information is presented for each series or model. Read this manual carefully at your first opportunity and keep it in a convenient location for later reference. You will be particularly interested in the "break-in" instructions starting on Page 14, and the maintenance instructions starting on Page 27.

If, at any time, you have a question or problem concerning your new tractor, remember that your Ford Tractor and Implement Dealer is best qualified and equipped to serve your needs. With the proper treatment and service, your Ford Tractor should provide you with a long life of profitable and dependable service.

TRACTOR AND IMPLEMENT DIVISION
FORD MOTOR COMPANY
SERVICE DEPARTMENT





TRACTOR MODEL AND SERIAL NUMBER

Ford Tractors are identified by the model numbers 640, 650, 660, 850 and 860. These numbers identify the type of tractor, engine, transmission, clutch and axle.

When ordering parts or requesting information from your Ford Tractor and Implement Dealer, always specify the Model and Serial Number of your Ford Tractor.

The Model and Serial Number is located on the left front side of the transmission housing and should be recorded immediately in the space provided below.

MODEL

SERIAL NO.



CONTROLS AND INSTRUMENTS

The controls on your new Ford Tractor are designed to help you do more work with the greatest possible convenience and comfort. All are within easy reach and are simple to operate.

The well-grouped instruments tell you, at a glance, whether the engine is operating efficiently and warn you of the possibility of trouble before it becomes serious.

Before attempting to start or operate your new tractor, familiarize yourself with the location and function of all controls and instruments.

CONTROLS AND INSTRUMENTS

TRACTOR SEAT

Take your place in the tractor seat. If the seat is not in the most comfortable operating position, it may be moved forward or rearward as desired. The seat pan may be tilted back, permitting the operator to stand, or to protect it from dew and rain. Series 800 tractors are equipped with a Rest-O-Ride seat which may be adjusted to accommodate the weight of individual operators.

LIGHT SWITCH

The tractor lights are operated by means of a switch on the lower right side of the instrument panel, just below the side panel. Pull the switch out to turn the lights on.

IGNITION SWITCH

The ignition switch is located on the lower left side of the instrument panel, just below the side panel. Turn the key clockwise to turn the ignition on, and counter-clockwise to turn it off.

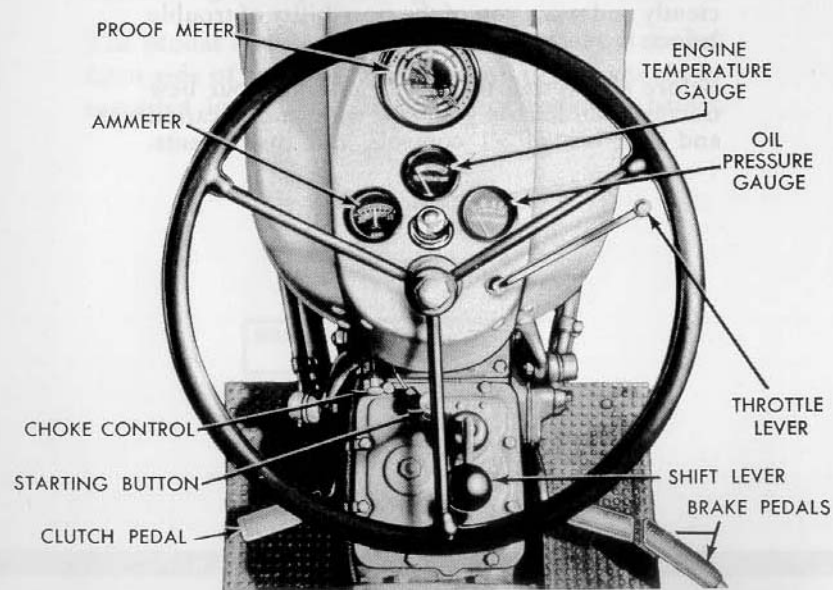
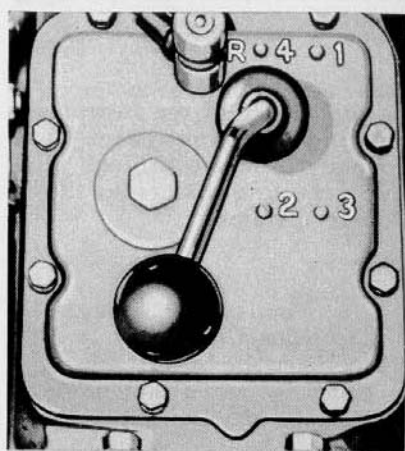

Figure 1
Controls and Instruments

CHOKE CONTROL

Initial starting may require the use of the choke control rod button, located to the left of the starter button. After the engine has been sufficiently warmed up, the choke button should be returned to its normal position as soon as possible.



4 SPEED TRANSMISSION

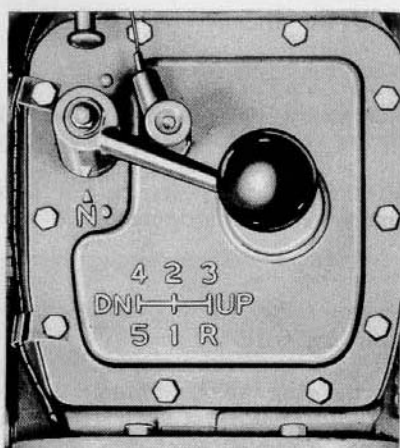

5 SPEED TRANSMISSION

Figure 2
Gear Shift Positions

GEAR SHIFT LEVER

The gear shift lever is located directly in front of the tractor seat.

For your convenience, a diagram of the shift pattern is provided on the transmission cover. The shift positions for both four and five speed transmissions are shown in Figure 2.

STARTER BUTTON

The Ford Tractor is equipped with a safety type starter button, located on top of the transmission housing within easy reach of the operator. The safety feature incorporated in the starter makes it impossible to depress the starter button without first placing the gear shift lever in the neutral position.

THROTTLE CONTROL

The hand operated throttle control is located at the right side of the steering wheel column. Pull the lever down to increase the engine speed.

OIL PRESSURE GAUGE

The engine oil pressure gauge indicates the oil pressure through oil passages, but does not show the amount of oil in the crankcase. Oil in the crankcase can become dangerously low and still show pressure on the gauge. Check the pressure gauge periodically when operating your tractor to be sure that the lubrication system is operating satisfactorily.

TEMPERATURE GAUGE

The engine temperature gauge at the top center of the instrument cluster registers the temperature of water in the cooling system. Form the habit of checking this gauge frequently. The green block indicates normal temperature, red indicates overheating and orange shows that the engine is operating at too cold a temperature.

AMMETER

The ammeter indicates current flow into or out of the battery. The ammeter will register a low charge rate when the battery is fully charged, and will show a high charge rate when the battery is in need of charging. If the ammeter registers discharge when the engine is running at normal speed, stop the tractor and determine the cause.

CLUTCH PEDAL

The foot operated clutch pedal, located on the left side of the transmission housing, must be depressed to disengage the clutch. For information on the live PTO clutch (Tractor Models 660 and 860), see the section on power take-off operation, page 20.

BRAKE PEDALS

Foot operated brake pedals are provided on the right side of the transmission housing. To stop the tractor, depress both pedals simultaneously. Apply the right brake when making short right turns, and the left brake when turning left.

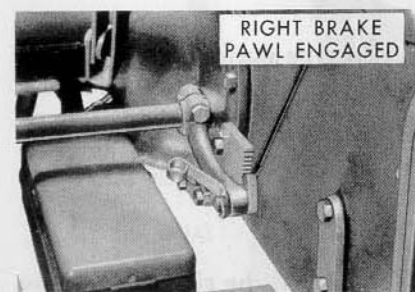

Figure 3
Brake Pawl Engaged

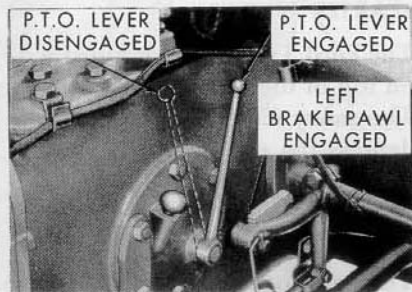

Figure 4
Power Take-Off Lever Engaged

BRAKE PEDAL LOCKS

Brake locks, located on the right and left sides of the rear axle housing, should always be set before leaving the tractor. To lock the right brake, move the brake pawl lever rearward before applying the brake. Move the left pawl lever toward the front to lock the left brake. See Figures 3 and 4. Reverse the above procedure to release the brakes.

POWER TAKE-OFF LEVER

The power take-off lever is located on the left side of the center housing. The power take-off is engaged when the lever is in the rear position (see Figure 4), and disengaged when the lever is forward. Always depress the clutch pedal when engaging or disengaging the power take-off while the tractor engine is running.

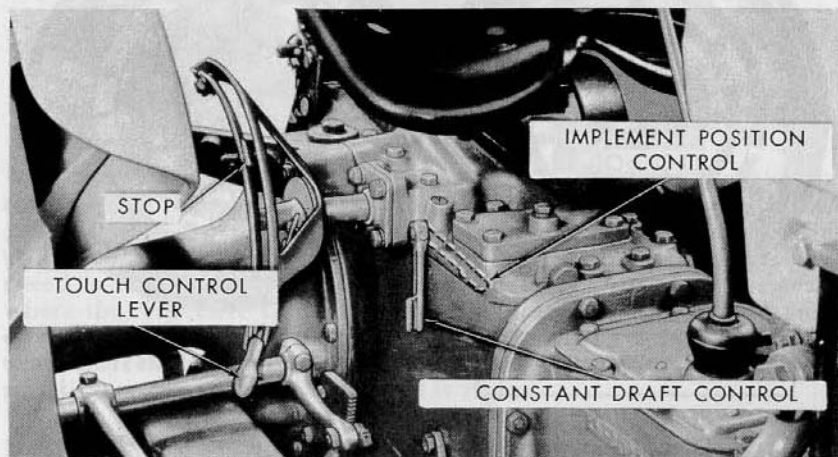

Figure 5
Hydraulic Control Levers

HYDRAULIC TOUCH CONTROL LEVER

The touch control lever, which controls the hydraulic system, is the large lever to the right of the tractor seat. To raise the lift arms, raise the lever to the top position. To lower the lift arms, push the lever to the lower position.

SELECTOR LEVER

The selector lever under the tractor seat changes the hydraulic system from constant draft to implement position control. Place the lever in the "Down" position for Constant Draft Control, and in the "Up" or horizontal position for Implement Position Control.

FUEL SHUT-OFF VALVE

The fuel shut-off valve is located at the center underside of the fuel tank (see Figure 28). Turn the valve to the right (clockwise) to shut off the fuel supply to the carburetor. Turn the valve (counterclockwise) to the stop to allow the fuel to flow. A reserve supply of one gallon of fuel is maintained when the valve is turned two turns from either the full open or closed positions. See decal located on underside of hood.

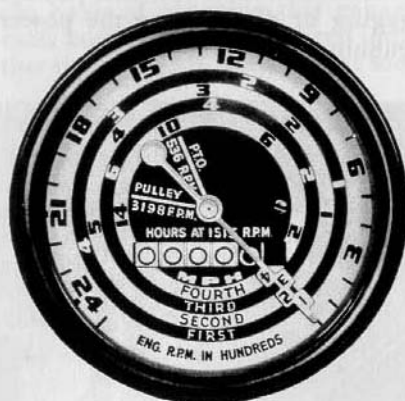

4 SPEED TRANSMISSION

Figure 6
Proof-Meter
Model 640



5 SPEED TRANSMISSION

Figure 7
Proof-Meter
Models 650, 660, 850, 860

PROOF-METER

The Ford Tractor Proof-Meter, conveniently located at the top center of the instrument panel, is actually five instruments in one. At a quick glance, it tells you the engine speed, tractor ground speed, P.T.O. speed, belt pulley F.P.M. and hours worked. The separate functions of the Proof-Meter are described in the following paragraphs and illustrations.

Engine Speed: Engine revolutions per minute (R.P.M.) are shown in hundreds on the outer band of the Proof-Meter as the long needle moves from 0 to 24. Knowing the correct engine speed is helpful in checking correct oil pressure and maintaining the proper engine idle speed.

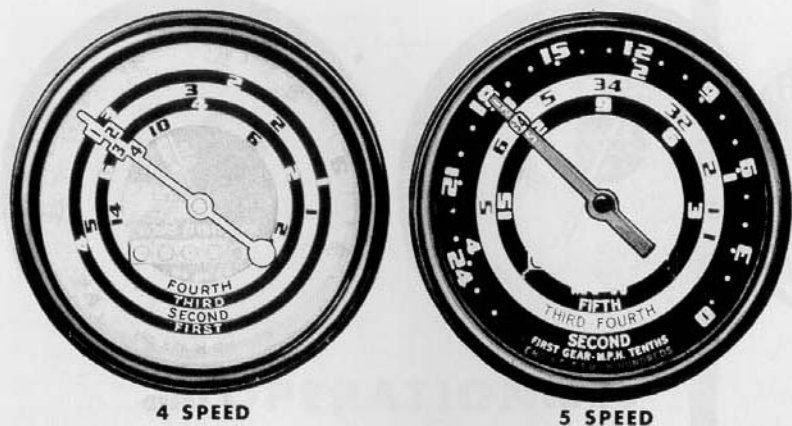
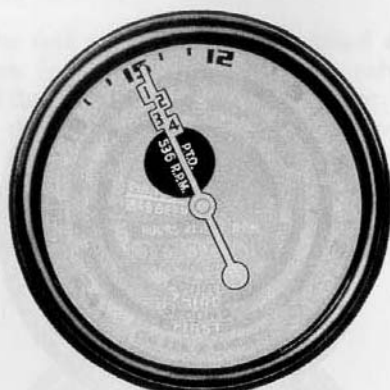

Figure 8
Tractor Ground Speed (M.P.H.)

Tractor Ground Speed: The ground speed (M.P.H.) on Model 640 tractors with four speed transmissions is indicated by the long needle, and is read in the band directly under the gear number on the needle as shown in Figure 8. On tractors with five speed transmissions, the speed is read in the same manner except in third and fourth gear, where the respective speeds are indicated in different colors. In field operations such as mowing, planting, spraying and combining, proper tractor speed is very important. With the Proof-Meter, you can be sure that your tractor ground speed is right.

P.T.O. Speed: The American Society of Agricultural Engineers (A.S.A.E.) standard for power take-off speed is 526 to 546 revolutions per minute as shown in Figure 9. Most power take-off implements will operate at maximum efficiency when the Proof-Meter needle is held at this speed. For further information on the Power Take-Off, refer to Page 20 of this manual.

Belt Pulley Speed: The performance of most stationary farm implements is better and safer when they are operated at the correct belt pulley speed. The A.S.A.E. has standardized the belt speeds on farm tractors at 3000 to 3200 feet per minute. With the standard 9-inch belt pulley on the Model 640, Ford Tractor (sold as extra equipment), standard belt speed is 3198 feet per minute at 2000 engine R.P.M. as shown on the four speed Proof-Meter. (See Figure 10.) On tractors with five speed transmissions, the standard belt speed is 3015 feet per minute at 2200 engine R.P.M. Additional information on operating the belt pulley is included in the section on OPERATION, Page 21 of this manual.



4 SPEED



5 SPEED

Figure 9
Power Take-Off Speed

Engine Hours: The hour meter portion of the Proof-Meter represents the hours your tractor engine has "worked," based on an average engine speed of 1515 revolutions per minute. Engine speeds below 1515 revolutions accumulate hours more slowly than clock hours, and those above 1515 R.P.M. register faster than clock hours. Use this feature of the Proof-Meter to determine when service and maintenance are necessary. It will help you cut operating costs and prolong the life of your new tractor.

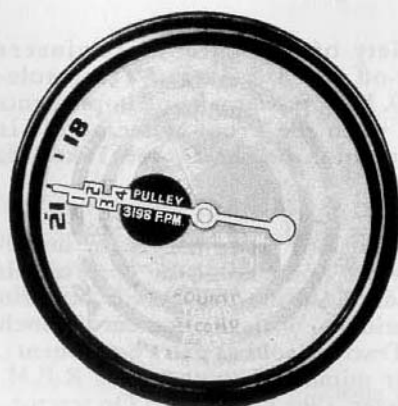

4 SPEED

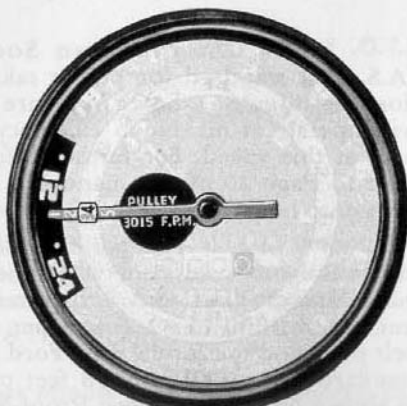

5 SPEED

Figure 10
Belt Pulley Speed



OPERATION

Your new Ford Tractor has been built with the knowledge gained through manufacturing over two million farm tractors. In it you will find many new and exclusive features, designed to make your work easier, faster and more profitable.

After familiarizing yourself with the tractor controls and instruments, read the following instructions on OPERATION. They will help you obtain maximum efficiency and dependable operation from your new Ford Tractor.

OPERATION

PRE-STARTING CHECK

Your Ford Tractor and Implement Dealer has checked your tractor thoroughly. We suggest, however, that you double check the tractor before placing it in operation. Make certain that the crankcase, transmission, hydraulic system and rear axle are filled to the recommended level. Check the tires for proper air pressure and be sure that the radiator is filled with coolant.

BREAK-IN PROCEDURE

Your new Ford Tractor should provide long and dependable service if given a good start by you, the operator. During the first 50 hours of operation, do not work the tractor at full capacity. Run the engine at slow speeds and use low transmission speeds. Check the instruments frequently and keep the radiator and oil reservoirs filled to the recommended level.

After 50 hours of operation, see your Ford Tractor and Implement Dealer. He will perform all necessary checks and adjustments in the **50 HOUR SERVICE AND INSPECTION**, authorized by your Service Policy.

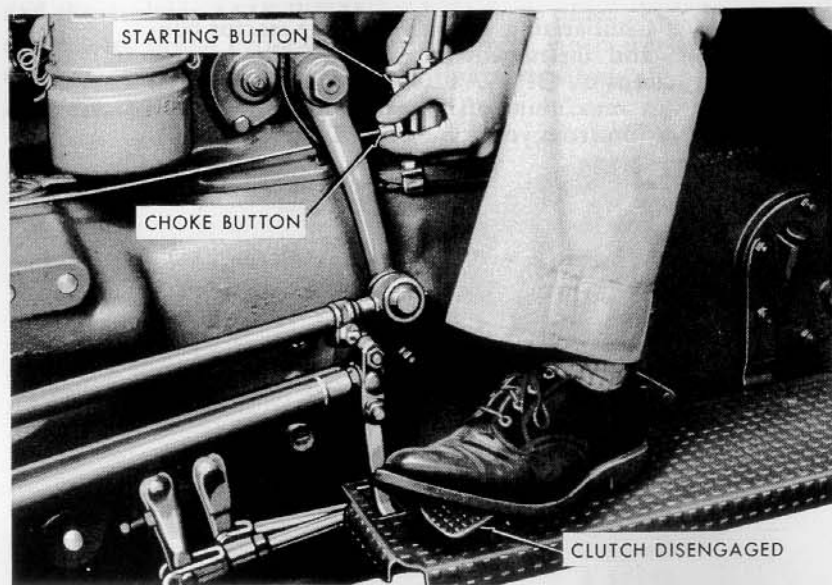

Figure 11
Using the Starter Button, Choke and Clutch Pedal

STARTING THE ENGINE

To start the engine under normal weather conditions, move the throttle lever to approximately $\frac{1}{4}$ open position, set the gear shift lever in neutral and turn the ignition key clockwise. Then, simply depress the clutch pedal and press the starter.

Initial starting of the engine, or extremely cold weather, may require the use of the choke. Under these conditions, pull out the choke rod button and depress the starting button at the same time. As soon as the engine starts, push the choke in to its normal operating position. Run the engine at about 1000 RPM until it warms up before placing it under a load.

OPERATING THE TRACTOR

Start the engine, release both rear wheel brake locks and depress the clutch pedal. Next, move the gear shift lever to the desired gear speed. The shift positions are clearly indicated on the transmission cover and are shown in Figure 2.

You will save fuel and minimize engine wear by selecting the correct gear ratio for a particular field operation. Operating the tractor in low gear with a light load and high engine speed is a waste of fuel. "Lugging" occurs when the load for a particular gear and throttle setting is excessive. The following table shows the recommended ground and engine speeds for particular types of work.

RECOMMENDED GROUND AND ENGINE SPEEDS

Type of Work	MODEL 640				MODELS 650 & 660				MODELS 850 & 860			
	GEAR	1500 RPM	1750 RPM	2000 RPM	GEAR	1500 RPM	1750 RPM	2000 RPM	GEAR	1500 RPM	1750 RPM	2000 RPM
Heavy Work					1st	1.74	2.02	2.31	1st	1.67	1.95	2.22
	1st	2.78	3.24	3.70	2nd	2.76	3.22	3.67	2nd	2.64	3.08	3.52
Plowing	2nd	3.57	4.17	4.76	3rd	3.67	4.31	4.95	3rd	3.52	4.12	4.72
Cultivating	3rd	4.92	5.74	6.56	4th	5.07	5.92	6.77	4th	4.87	5.68	6.48
Light Work	4th	10.25	11.96	13.67	5th	11.05	12.89	14.73	5th	10.60	12.35	14.10
Reverse	Rev.	3.21	3.75	4.28	Rev.	2.96	3.46	3.95	Rev.	2.84	3.32	3.80

After shifting to the desired gear speed, increase the engine speed slightly and release the clutch pedal in the same manner as you would when driving an automobile. When the tractor is in motion, increase the ground speed as desired and remove your foot from the clutch pedal.

To stop the tractor, depress the clutch pedal and decrease the engine speed. Apply pressure evenly to both brake pedals until the tractor is stopped, then place the gear shift lever in the neutral position, lock the brakes and turn the ignition key off.

CAUTION: DO NOT ATTEMPT TO SHIFT GEARS WHILE THE TRACTOR IS IN MOTION, OR TOW TRACTOR FASTER THAN 20 M.P.H.

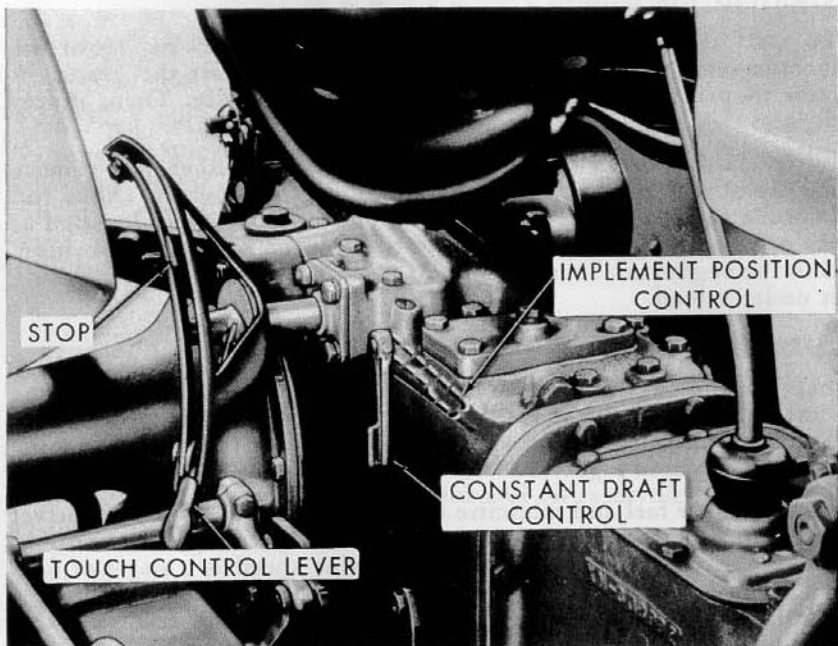

Figure 12
Hydraulic Control Levers

OPERATING THE HYDRAULIC SYSTEM

One of the outstanding features on your new Ford Tractor is the Live Action Hydraulic System. By simply moving the Touch Control Lever, the system provides instant hydraulic power for raising or lowering a wide variety of implements. Regardless of whether the clutch pedal is up or down, or whether the P.T.O. is engaged or disengaged, the system will respond smoothly, enabling you to adjust implements in fractions of an inch.

The system incorporates two types of hydraulic control. Depending upon the type of implement used and the soil conditions and terrain encountered, the system may be operated in Implement Position Control or in Constant Draft Control.

Implement Position Control: To operate the hydraulic system in Implement Position Control, move the selector lever under the tractor seat into the "UP" position (see Figure 12), and set the implement at the desired depth by moving the Touch Control Lever down. Where the ground is relatively level, the position control will keep the implement at the desired depth, even though the soil texture may vary.

By setting the adjustable stop on the quadrant, the implement can always be returned to the original depth by moving the Touch Control Lever down to the stop.

With the selector lever in the "DOWN" position, as shown in Figure 12, the hydraulic system is operating in Constant Draft Control. When an implement is lowered to work at a certain depth, the draft control will maintain the same draft, even though the ground contour or soil texture may change. If the draft increases, the hydraulic system will respond by raising the implement to decrease the draft. At the same time, the weight will shift to the tractor rear wheels, increasing traction until the implement has been automatically repositioned and the draft is decreased.

When necessary, the operator may use the Touch Control Lever to make small adjustments in the system.

The Hy-Trol Valve, located on the hydraulic pump (see Figure 13), controls the speed at which implements may be raised. The valve may be set at one of five positions, depending upon the type of implement being used. The slower speeds should be used for plowing and similar work, and the faster speeds (as shown) are recommended for use with auxiliary equipment such as loaders and remote cylinders.

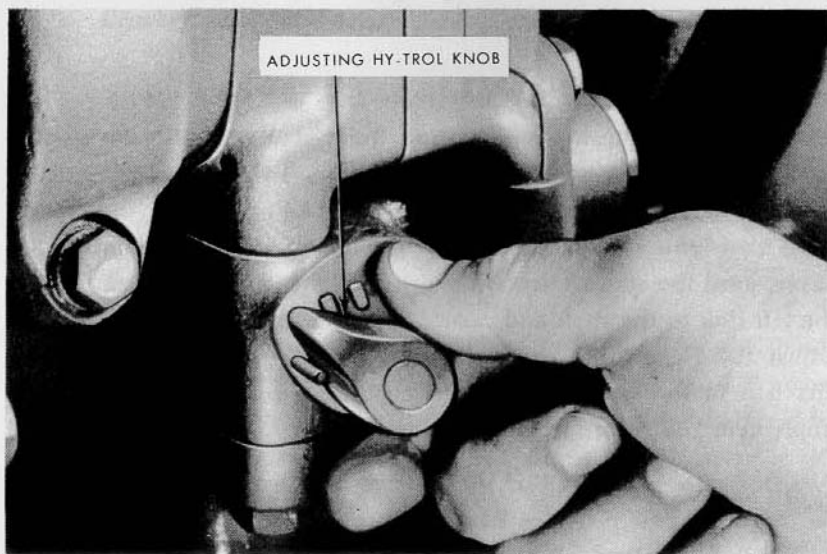

Figure 13
Adjusting Hy-Trol Knob

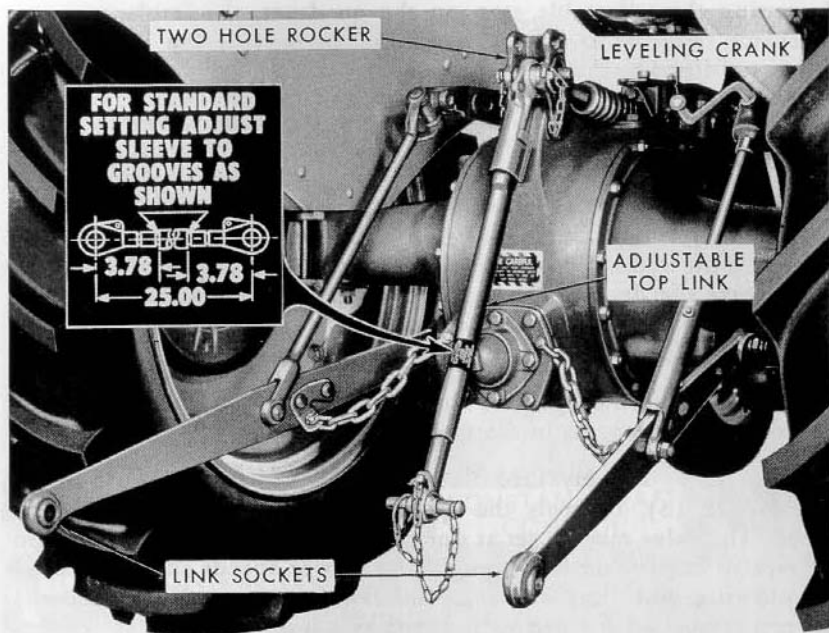

Figure 14

Leveling Crank and Adjustable Top Link

ATTACHING IMPLEMENTS

Most implements can be easily and quickly attached to the tractor three point linkage. With the selector lever in Implement Position Control, back the tractor so that the lift links are directly above the cross shaft of the implement. Lower the links with the Touch Control Lever, until the sockets are aligned with the ends of the shaft. Attach the left link to the shaft and secure with the linch pin provided, then adjust the right link with the leveling crank (see Figure 14) and attach it in the same manner. Attach the adjustable top link to the implement and secure it with the linch pin.

Two Hole Hydraulic Lift Rocker: The two hole hydraulic lift rocker on the Ford Tractor provides better control of sensitivity for light and heavy draft implements. Attach the top link in the upper hole for light draft loads (cultivating) and in the lower hole for heavy draft loads such as plowing.

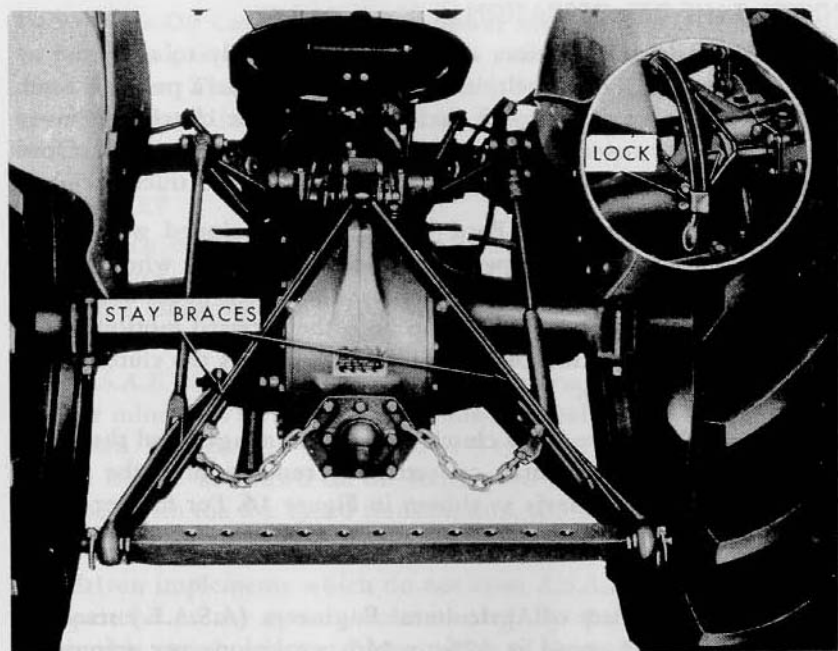

*Figure 15
Drawbar Stays Attached with Safety Chain and Lock Installed*

Adjustable Top Link: The fully adjustable top link provides improved implement performance and operation. The link may be adjusted to suit implement operation requirements by releasing the lock and rotating the sleeve until the desired length is obtained. The standard length of 25 inches is obtained by adjusting the link as shown on a decal located on the sleeve. (See insert, Figure 14.)

Drawbar Stays: Drawbar stays are provided as support for the standard drawbar when using pull type implements with your Ford Tractor. The lock chain, attached to the right drawbar stay, should always be installed on the quadrant to lock the Touch Control Lever in its "DOWN" position. If the Touch Control Lever is raised, the drawbar stays will be damaged.

A Swinging Drawbar, which swings 60° for short turns, is available for use on your Ford Tractor. (See Accessories, page 55.)

POWER TAKE-OFF OPERATION

The power take-off transfers engine power directly to mounted or drawn implements, or to belt driven equipment when a pulley is used. To operate the power take-off shaft, disengage the clutch and move the P.T.O. lever toward the rear of the tractor (see Figure 4). Once engaged, operation of the shaft is controlled by the tractor clutch.

The Model 660 and 860 Ford Tractors are equipped with a live PTO clutch. To stop the forward motion of the tractor when operating with PTO driven equipment, depress the clutch pedal about half way as shown in Figure 16. To stop both the forward motion of the tractor and the operation of the implement, depress the clutch pedal all the way, as shown.

When desired, the live PTO clutch may be disengaged and the pedal set for normal, single clutch operation by repositioning the pin in the front hole of the clevis as shown in Figure 16. For further information on clutch adjustments, see page 45 under MECHANICAL MAINTENANCE.

The American Society of Agricultural Engineers (A.S.A.E.) standard for power take-off speed is 526 to 546 revolutions per minute as shown on the Proof-Meter. Most power take-off implements are designed to operate at this speed.

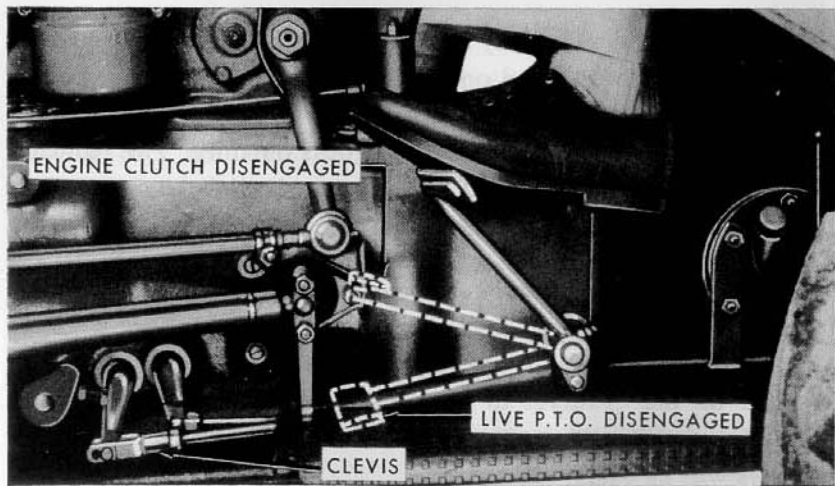

Figure 16

Operating the Live PTO Clutch

Power Take-Off Conversion Kit: A power take-off conversion kit may be purchased, as extra equipment, from your Ford Tractor and Implement Dealer. This kit adapts the Ford Tractor P.T.O. to A.S.A.E. specifications. All implements built to these standards may, therefore, be hitched to your Ford Tractor with this assembly.

BELT PULLEY

A nine-inch belt pulley is available as an accessory for use on your Ford Tractor. The pulley can be installed in any one of three positions, by simply removing the P.T.O. shaft safety cap and the check chain anchors.

The A.S.A.E. standard belt speed for farm tractors is 3000 to 3200 feet per minute. With the standard nine-inch belt pulley on the Model 640 Ford Tractor, the belt speed is 3198 feet per minute at 2000 engine R.P.M. as shown on the four speed Proof-Meter. On models equipped with the five speed transmission, the belt speed is 3015 feet per minute at 2200 engine R.P.M.

Belt driven implements which do not meet A.S.A.E. standards should be operated at the speed recommended by the manufacturer. To obtain this speed, select a driven pulley of the proper size from the table below.

PROPER SIZE OF THE DRIVEN PULLEY*

Engine R.P.M. 4 Speed Transmission	Engine R.P.M. 5 Speed Transmission	Pulley R.P.M.	R.P.M. OF THE DRIVEN PULLEY									
			600	800	1000	1200	1400	1800	2200	2600	3000	
1000	1168	679	10	7½	6	5	4½	3½	3			
1100	1285	747	11	8½	6½	5½	5	3½	3			
1200	1402	815	12	9	7½	6	5	4	3½	3		
1300	1517	882	13	10	8	6½	5½	4½	3½	3		
1400	1634	950	14	10½	8½	7	6	4½	4	3½	3	
1500	1751	1018	15	11½	9	7½	6½	5	4	3½	3	
1600	1868	1086	16½	12	10	8	7	5½	4½	4	3½	
1700	1985	1154	17½	13	10½	8½	7½	6	4½	4	3½	
1800	2102	1222	18½	13½	11	9	8	6	5	4	3½	
1900	2219	1290	19½	14½	11½	9½	8½	6½	5½	4½	4	
2000	—	1358	20½	15½	12	10	8½	7	5½	4½	4	

*Figures are computed to the nearest ½ inch pulley size.

CAUTION: NEVER INSTALL OR REMOVE BELT WHILE PULLEY IS IN MOTION.

WHEEL TREAD ADJUSTMENTS

The unique design of the Ford Tractor permits a wide range of front and rear wheel adjustments which can be made quickly and easily. To make the job safer and more convenient, however, we recommend the use of the Dearborn Tractor Jack. With it, you can utilize your tractor hydraulic system to raise either the front or rear wheels off the ground.

Front Wheel Tread Adjustment: The front wheels are adjustable from

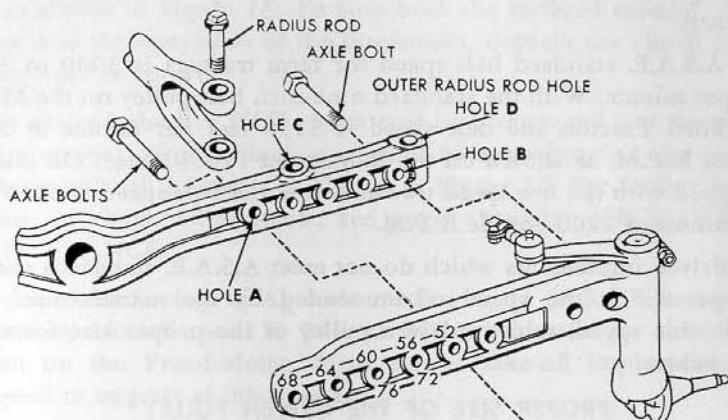

FOR TREAD WIDTH (INCHES)	LINE UP HOLE A AND HOLE NO.	LINE UP HOLE B AND HOLE NO.	SPACE BOLTS APART (INCHES)	SET RADIUS ROD TO HOLE	RADIUS RODS SPREAD (INCHES)
52	52		8½	C	29.08
56	56		8½	C	29.08
60	60		6¾	D	40.82
64	64		8½	D	40.82
68	68		8½	D	40.82
72		72	6¾	D	40.82
76		76	4¼	D	40.82
80†		72	6¾	D	40.82

† REVERSE WHEELS ON AXLE HUBS.

NOTE: ADJUST DRAG LINKS—SEE FRONT WHEEL TOE-IN

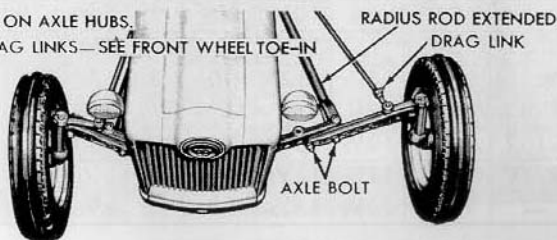

Figure 17
Front Wheel Tread Adjustments

52 to 76 inches in 4 inch spacings. To change the tread width, raise the front end of the tractor with a jack and remove the bolts which hold the outer axle sections to the center section. Move the front wheels apart until the desired tread width is obtained (see Figure 17), then replace the bolts and tighten securely. Always leave one or more open holes between the bolts.

When absolutely necessary, a wider tread width of 80 inches can be obtained by reversing the wheels and setting the tread width at 72 inches.

NOTE: When front wheel adjustments are made, the drag links must be adjusted to obtain proper front wheel toe-in. See page 46, under MAINTENANCE.

The tractor rear wheels are adjustable to the same tread widths as the front wheels. Tread width settings are made by changing the position of the steel discs and the rims to any of the positions shown in Figure 18. To change from the 52 inch

INTER-CHANGING REAR WHEEL ASSEMBLIES GIVE THESE COMBINATIONS

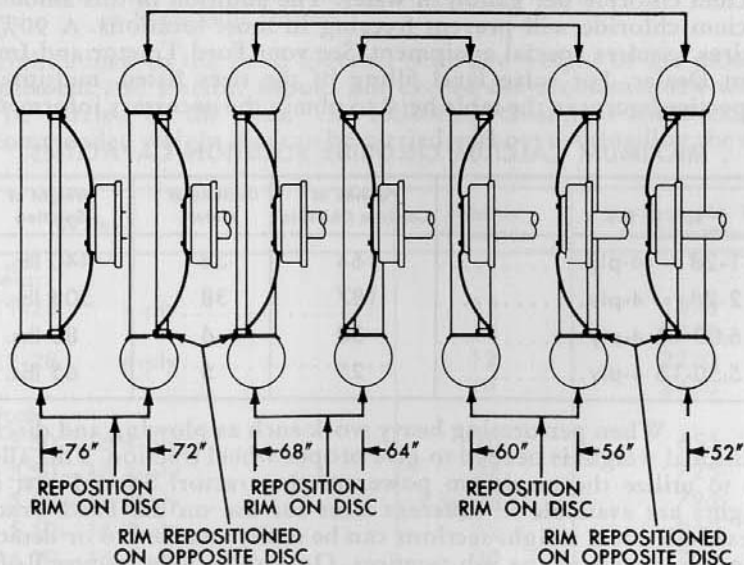

Figure 18
Rear Wheel Tread Adjustments

tread width to the 72 inch width, it is only necessary to change the wheels from one side of the tractor to the other. Two other wheel changes are similar as shown at the top of Figure 18.

NOTE: THE ARROW ON THE SIDE WALL OF THE TIRE SHOULD ALWAYS POINT IN THE DIRECTION OF FORWARD ROTATION OF THE WHEEL.

WHEEL WEIGHT

It will be necessary, during some farm or industrial operations, to add weight to the wheels of your Ford Tractor. Two methods of adding weight are available as described below.

Calcium Chloride: One of the most popular methods of adding weight is to fill the tires with a liquid. A calcium chloride solution is recommended because it has a lower freezing point and weighs more per gallon than water.

Liquid may be added to the front tires to counter-balance heavy implements on the rear links. However, this should be done only when absolutely necessary, since excessive weight results in wasted fuel and added loads on the engine.

The recommended liquid capacities for tires are shown in the table below. This table is based on a 90% fill of the tires with 5 pounds of calcium chloride per gallon of water. The addition of this amount of calcium chloride will prevent freezing in most locations. A 90% fill of tires requires special equipment. See your Ford Tractor and Implement Dealer. For valve level filling of the tires listed, multiply the respective figures in the table by .8 to obtain the necessary information.

MAXIMUM CALCIUM CHLORIDE SOLUTION CAPACITIES

Size of Tire	Pounds of Calcium Chloride	Gallons of Water	Weight of Solution
11-28 4-ply.....	164	32	440 lbs.
12-28 4-ply.....	187	38	504 lbs.
6:00-16 4-ply.....	30	6	80 lbs.
5:50-16 4-ply.....	25	5	65 lbs.

When performing heavy work such as plowing and discing, additional weight is needed to give proper wheel traction. This allows you to utilize the maximum power of the tractor. Special cast iron weights are available in different sizes for use on the Ford Tractor. These individual weight sections can be easily attached to or detached from the wheels as the job requires. On lighter jobs, removal of the weights will increase the operating economy of your tractor. The following chart describes the different types of weights and their recommended usage.

FORD TRACTOR WHEEL WEIGHTS	SERIES 600		SERIES 800	
	Farm Use	Industrial Use	Farm Use	Industrial Use
FRONT (per tractor set) Wheel Weights—Inside mounted Two per wheel—50 lbs. each Total—200 lbs.	X	X	X	X
REAR (per tractor set) Regular Duty Weights Two Mounting Discs—68 lbs. Segments—(24) 30 lbs. each Bolts—12 lbs. Total—800 lbs. *Heavy Duty Weights Two Mounting Discs—68 lbs. Segments—(24) 45 lbs. each Bolts—12 lbs. Total—1160 lbs. Inside Segmented (Industrial) Segments (8)—100 lbs. each Total—800 lbs.	X	X	X	X

*CAUTION: Under no circumstances should Heavy Duty Weights be used on Series 600 Tractors.

Weight added to the tires, together with the weight of the mounted implement and tractor, should not exceed the recommended weight to be carried by the tires. The following table lists the maximum recommended weight that can be carried without overloading the tires.

Tire Size	Inflation Pressure	Maximum Lbs. Tire Load Per Wheel
Rear:		
11-28 4-ply.....	12	1890
	14	2070
12-28 4-ply.....	12	2220
	14	2430
Front:		
5.50—16 4-ply.....	20	655
5.50—16 4-ply.....	24	725
5.50—16 4-ply.....	28	795
5.50—16 4-ply.....	32	860
6.00—16 4-ply.....	20	750
6.00—16 4-ply.....	24	835
6.00—16 4-ply.....	26	875

Watch Your Proof-Meter Decal

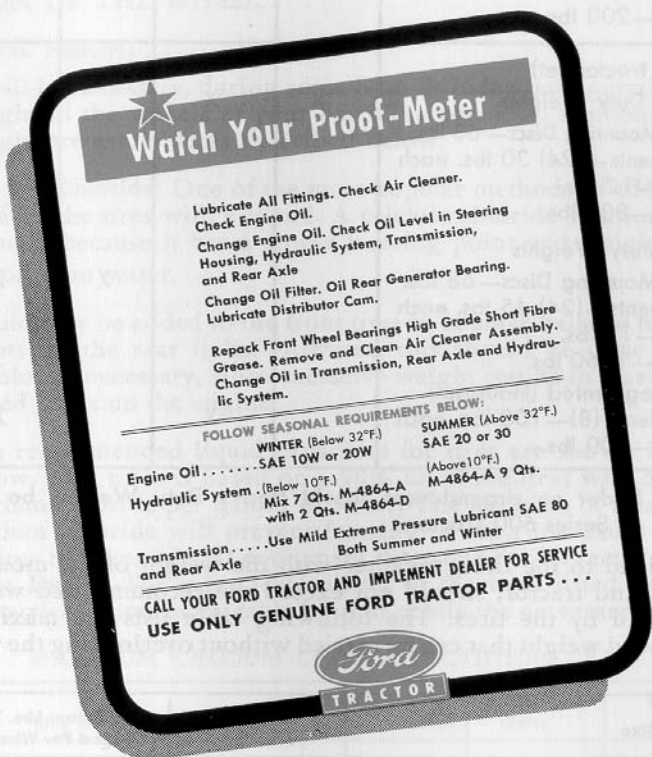

To emphasize the importance of establishing regularly scheduled lubrication periods, a copy of the above decal is fixed to the inside of every tractor hood. The information on the decal has been condensed from the lubrication information on pages 28 through 33. Watch your Proof-Meter and use the decal as a reminder of the lubrication services required by your tractor.



MAINTENANCE

How long and how well your Ford Tractor continues to give satisfactory performance depends largely upon proper maintenance. Keep the tractor in good working order by following the instructions in this section on lubrication, mechanical maintenance, minor adjustments and storage.

When major overhauls become necessary, see your Ford Tractor and Implement Dealer. He is interested in you and your tractor, and is properly equipped to meet your service needs.

MAINTENANCE

PRE-DELIVERY INSPECTION

Before your tractor was delivered to you, the dealer performed a pre-delivery inspection which is the first step in the maintenance schedule of your tractor. Some of the more important items checked by your dealer are the cooling system, front end, engine, transmission, hydraulic system, rear end, and the general physical condition of your new tractor. A detailed listing of the inspections performed is shown on your Service Policy under the Pre-Delivery and 50-Hour Inspection Reports.

50 HOUR INSPECTION

After you have operated your tractor for a period of fifty hours, see your Ford Tractor and Implement Dealer. At this time, he will perform the factory recommended 50-Hour Inspection, without charge, except for lubricants. Remember that the dealer is interested in your tractor's performance. See him periodically for continued good service.

LUBRICATION

Since your tractor will be subjected to a variety of operating conditions, it is extremely important that all moving parts be lubricated at the proper time. Avoid causing serious damage to your tractor by using clean containers and recommended grades of lubricant.

The following guide describes, in hourly intervals, all of the lubrication services required by your tractor. These time intervals are based on average working conditions. When operating under extremely hot or dusty conditions, lubricate the tractor more frequently.

The location of the lubrication points described in the lubrication guide are shown in Figures 23 and 24 on pages 32 and 33.

SERVICE DAILY OR EVERY TEN HOURS

Crankcase Ventilating System: Remove the element in the Rocker Arm Cover Breather and clean with a suitable solvent. Coat the element with light engine oil before replacing.

Oil Filler Breather Cap: Remove the element, clean the entire assembly with solvent and coat the element with light engine oil.

Air Cleaner: Wash the air intake screen in solvent and clean the oil cup. Refill the cup with 1.3 pints of engine oil. (Under extremely dusty conditions, service more often.)

Pressure Type Fittings: Clean the fittings on the Lift Rod Leveling Box and Fork, Front Axle Spindles, Clutch Pedal and Steering Drag Links. Apply pressure gun grease and wipe the fittings clean. See Figure 23.

Distributor: Place a few drops of seasonal engine oil in the oil cup. Do not over lubricate. (See Figure 20.)



Figure 19
Checking the Air Cleaner Oil Level

Crankcase Dip Stick: Remove the dip stick from the right side of the engine crankcase. Always wipe the dip stick with a clean cloth, replace it and then remove it again to determine the oil level. Maintain the level at the full mark with a good grade of heavy duty or premium engine oil. (See SERVICE EVERY 100 HOURS.)

Hydraulic System Dip Stick: Check the level of the hydraulic oil on the dip stick and maintain at the full mark with the proper lubricant as recommended under SERVICE EVERY 600 HOURS. *When checking the hydraulic oil level, always be sure all hydraulic cylinders are fully extended.*

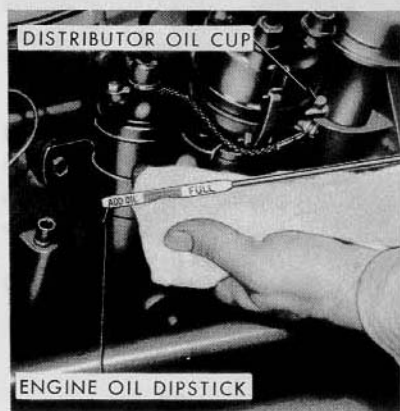

Figure 20
Crankcase Oil Level Dip Stick

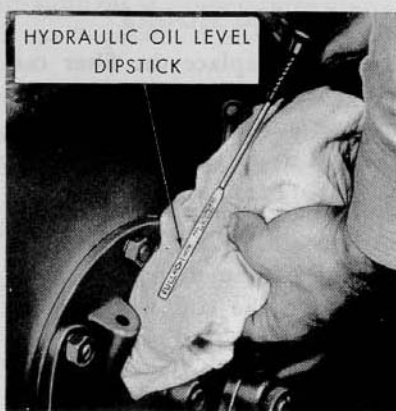

Figure 21
Hydraulic Oil Level Dip Stick

SERVICE EVERY 100 HOURS

Engine Crankcase: Change the engine oil in your new tractor at the 50 hour inspection and every 100 hours of operation thereafter. Drain the oil after the engine has reached normal operating temperature. Refill the crankcase with four quarts of good heavy duty or premium engine oil and add one extra quart of oil if the filter cartridge is replaced.

SAE 30 —Temperatures consistently above 90° F.

SAE 20 —Temperatures between 90° F. and 32° F.

SAE 20W—Temperatures between +32° F. and +10° F.

SAE 10W—Temperatures between +10° F. and -10° F.

SAE 5W—Temperatures below -10° F.

Rear Axle: Remove the rear axle inspection plug (11), Figure 23, and check the level of the oil. If necessary, add oil. (See SERVICE EVERY 600 HOURS.)

Remove the transmission oil level inspection plug (20), Figure 23, and add oil, if required. (See SERVICE EVERY 600 HOURS.)

Steering Housing: Check the oil level at the steering gear case plug (18), Figure 23, and add lubricant as required. Use extreme pressure gear lubricant SAE 90 in the summer and SAE 80 in the winter.

SERVICE EVERY 200 HOURS

Oil Filter: Replace the filter cartridge with every other engine oil change and add one quart of engine oil to fill the new cartridge.

Distributor: Remove the cap and dust shield. Wipe the cam, the outside of the distributor, the wires and the coil with a clean cloth. Apply a portion of distributor lubricant about the size of a match head on the distributor cam. Use Ford Distributor Lubricant only.

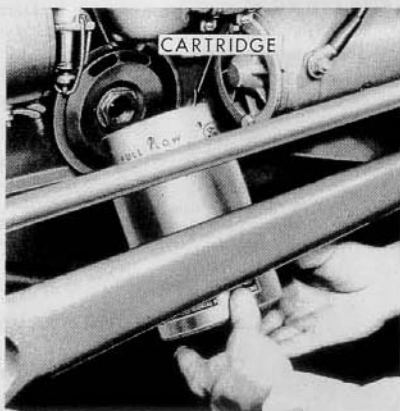

Figure 22
Replacing the Oil Filter
Cartridge

Generator: Oil the generator rear bearing with light oil. Do not over lubricate.

SERVICE EVERY 600 HOURS

Front Wheel Bearings: Clean the front wheel bearings thoroughly with a solvent and repack with a high grade short fibre grease. Lubricate the spindle shaft before replacing the bearings.

Air Cleaner: Disassemble the air cleaner and clean the filtering mesh and tube thoroughly with solvent. Refill the cup with 1.3 pints of engine crankcase oil. When operating under dusty conditions, clean every 100 hours.

Transmission: Change the transmission oil at the 50 hour inspection and every 600 hours of operation thereafter. In winter operate the tractor to thin the oil before draining. Fill the 4 speed transmission with 6½ quarts of extreme pressure lubricant and the 5 speed transmission with 8 quarts.

Use mild extreme pressure lubricant SAE 80, both summer and winter.

Hydraulic System: After the first 50 hours and after every 600 hours operation, change the oil in the hydraulic system. In winter, operate the system to thin the oil before draining. Clean the fill port carefully before removing to prevent dirt from entering the system. Fill the system with 9 quarts of M-4864-A hydraulic oil at temperatures above 10° F. At temperatures below 10° F., use 7 quarts of M-4864-A and 2 quarts of M-4864-D hydraulic oil.

Rear Axle: Replace the oil in the rear axle after the first 50 hours of operation and following every 600 hours thereafter. In winter, operate the tractor to thin the oil before draining. Refill Series 600 axles with 8½ quarts of oil, and Series 800 axles with 11½ quarts.

Use mild extreme pressure lubricant SAE 80, both summer and winter.

NOTE: *The tractor rear wheel bearings are sealed and require no further lubrication for the life of the tractor.*

EVERY 10 HOURS

17 CRANKCASE VENTILATING SYSTEM—
Clean and Oil

12 OIL FILTER BREATHER CAP— Clean and Oil

6 AIR CLEANER—
Clean and Oil

13 DISTRIBUTOR— Few Drops of Engine Oil in Cup

16 CRANKCASE DIP STICK— Check Oil Level

21 HYDRAULIC SYSTEM DIP STICK—
Check Oil Level

LUBRICATE PRESSURE FITTINGS BELOW:

2 DRAG LINKS (FRONT)

4 SPINDLE PINS

19 DRAG LINKS (REAR)

7 CLUTCH PEDAL (640)

9 CLUTCH PEDAL (OTHERS)

23 LEVELING BOX

TOP VIEW OF TRACTOR

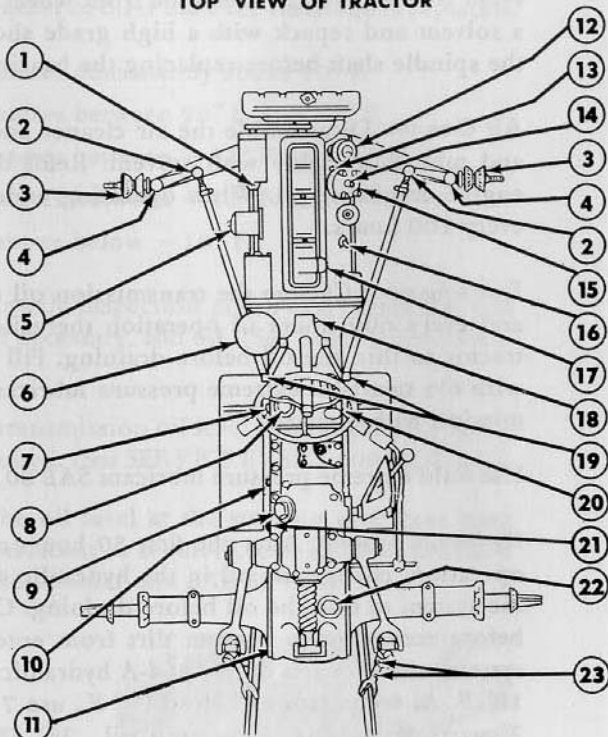

Figure 23

EVERY 100 HOURS

12 ENGINE CRANKCASE— Drain and Refill:
and Winter (Below 32° F.) S.A.E. 10W or 20W
24 Summer (Above 32° F.) S.A.E. 20 or 30

11 REAR AXLE— Check Oil at Level Plug on
and Side of Housing and Add Oil if
22 Necessary.

20 TRANSMISSION— Check Oil at Level
and Plug on Side of Housing and Add Oil if
8 Necessary.

21 HYDRAULIC SYSTEM— Check Oil Level

18 STEERING HOUSING— Check Oil Level

UNDERSIDE VIEW OF TRACTOR

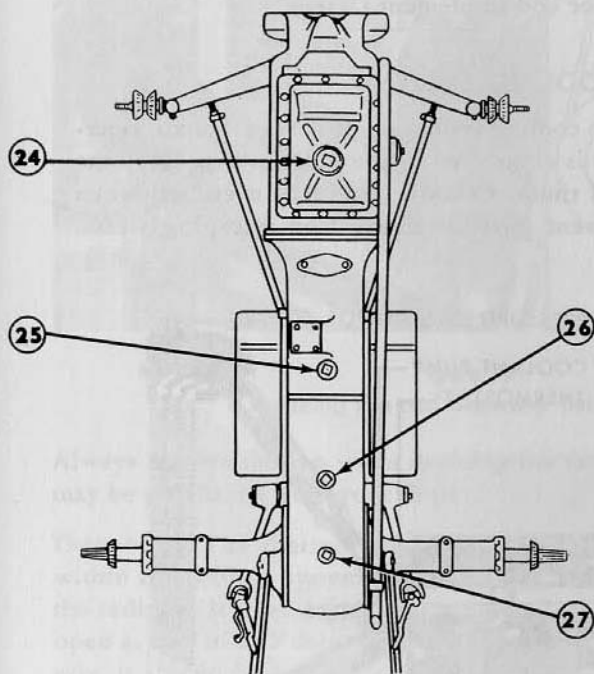

Figure 24

EVERY 600 HOURS

3 FRONT WHEEL BEARINGS—Repack with High Grade Short Fibre Grease

6 AIR CLEANER—Remove, Disassemble and Clean Complete Assembly—1.3 pints of Engine Crankcase Oil

25 TRANSMISSION—Drain and Refill (Use Mild Extreme Pressure Lubricant SAE 80, Both Summer and Winter)

26 HYDRAULIC SYSTEM and
10 —Drain and Refill (Below 10° F.—Mix 7 Qts. M-4864-A with 2 Qts. M-4864-D) (Above 10° F.—9 Qts. M-4864-A)

22 REAR AXLE—Drain and and
27 Refill (Use Mild Extreme Pressure Lubricant SAE 80, Both Summer and Winter)

EVERY 200 HOURS

5 OIL FILTER—Replace cartridge every other engine oil change and add one quart of oil to fill new cartridge.

1 GENERATOR—Oil rear bearing with light oil. Do not over lubricate.

14 DISTRIBUTOR—Light Film of Distributor Lubricant on Cam

MECHANICAL MAINTENANCE

In addition to lubrication services, regular mechanical maintenance is necessary to keep your tractor performing at maximum efficiency. The information in this section has been prepared to help you perform certain routine jobs on your tractor. Avoid breakdowns during the busy seasons by checking these items frequently and making the necessary repairs or adjustments. For major repair work or service parts, see your Ford Tractor and Implement Dealer.

COOLING SYSTEM

Radiator Pressure Cap: The cooling system on your Ford Tractor operates under pressure which is controlled by the radiator cap. Keep the cap installed tightly at all times. Caution should be exercised when removing the cap to prevent possible injury from escaping steam.

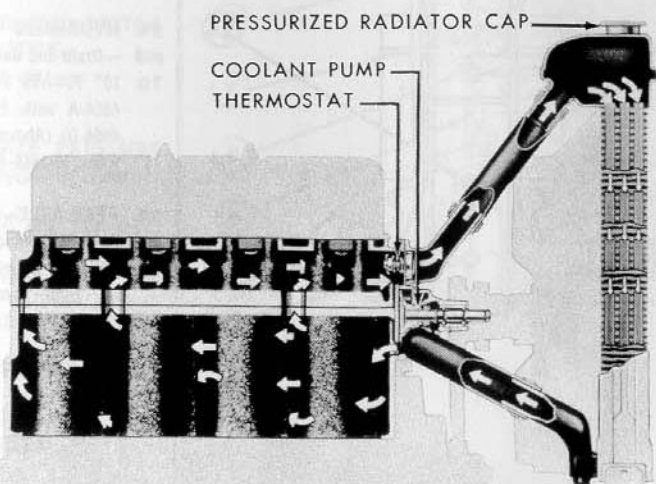

Figure 25
Ford Tractor Engine Cooling System

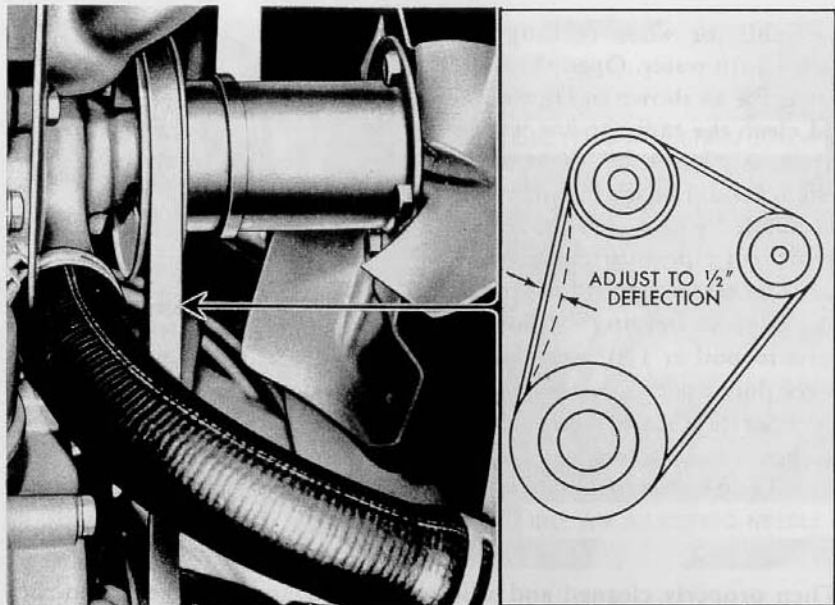

Figure 26
Adjusting Fan and Generator Belt Tension

Always remove the cap when draining the radiator. If lost, a new cap may be purchased from your dealer.

Thermostat: The thermostat automatically regulates the temperature within the cooling system by controlling the flow of coolant through the radiator. It should start to open at 157 to 162 degrees and be fully open at 177 to 182 degrees. If the thermostat does not function properly, it should be replaced.

Water Pump and Fan Belt: The water pump is driven by the fan belt. Check the belt periodically for proper tightness. Adjust the tension by loosening the two generator pivot bolts and the belt tension adjusting bolt. Move the generator away from the engine until a $\frac{1}{2}$ inch belt deflection is obtained with normal thumb pressure as shown in Figure 26.

Cleaning and Protection: The cooling system should be drained, flushed and refilled with clean, soft water every spring. Remove the thermostat prior to the flushing operation. Drain the system by opening the petcock at the bottom of the radiator, the drain cock on the left side of the cylinder block and the radiator cap. Add a good grade of

rust inhibitor when refilling the system with water. Open the radiator grille as shown in Figure 27, and clean the radiator fins with a wire brush. In the fall, the cooling system should be drained, flushed and refilled with a good grade of permanent type anti-freeze. Alcohol is not recommended as protection against freezing because it starts to boil at 170° and during heavy duty operation, the tractor may operate at temperatures above this figure. Anti-freeze may be purchased from your local dealer.



Figure 27
Opening Radiator Grille

FUEL SYSTEM

When properly cleaned and adjusted, the air and fuel system on the Ford Tractor will help provide maximum power and smooth engine performance with a minimum amount of fuel consumption.

Fuel Tank: Use only clean fuel which has been stored in a dry, cool place. At the end of each day of operation, refill the fuel tank to remove moisture laden air and reduce condensation. This is extremely important during cold weather.

Sediment Bulb: To clean the carburetor gas line sediment bulb, turn the fuel shut-off valve clockwise to the "OFF" position. Loosen the sediment bulb retaining nut, and move the retaining clamp sideways until the bowl can be removed. Remove and clean the disc screen and wipe the bowl with a clean cloth. Then replace the assembly and tighten securely. Always clean the fuel filtering screen in the sediment bulb when the bulb is cleaned. If the sediment bulb quickly accumulates an excessive amount of dirt after cleaning, the fuel tank should be drained and cleaned thoroughly.

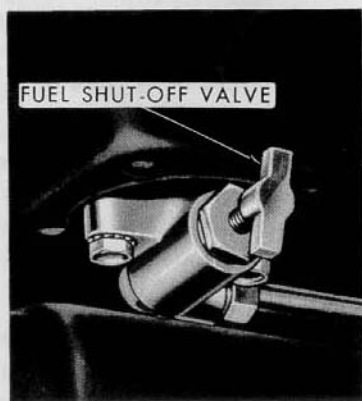

Figure 28
Fuel Shut-Off Valve Assembly

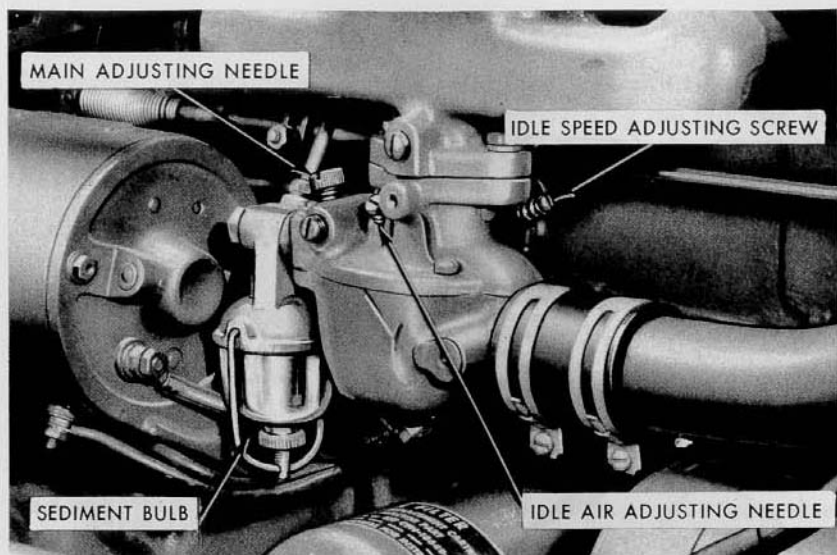

Figure 29
Adjusting the Carburetor

Carburetor: Three adjustments are provided on the carburetor. Before attempting to adjust the carburetor, however, the engine must be operated at normal temperature as shown on the gauge.

Idle Speed Adjustment Stop Screw: With the hand throttle in the closed position, turn the stop screw on the engine side of the carburetor until the engine idle speed is 450 to 475 R.P.M. on the Proof-Meter. On an engine that is not yet broken in, it may be necessary to set the idle speed higher to keep the engine from stalling at idle speeds.

Idle Air Adjustment Needle: For the initial setting, before the engine is started, turn the idle adjustment needle clockwise until it just seats, then back it off approximately one turn. Start the engine and turn the idle adjustment needle "IN" (clockwise) until the engine begins to "roll" from too rich a mixture, then back the needle off until the engine runs smoothly.

Main Adjusting Needle: The initial setting for the main adjusting needle is $1\frac{1}{4}$ turns open (counter-clockwise). The final adjustment should be made in the field. With the engine running at governed speed under full load, turn the adjustment needle "IN" (clockwise) until the engine power just begins to drop off, then turn the screw "OUT" until the power picks up and the engine runs smoothly.

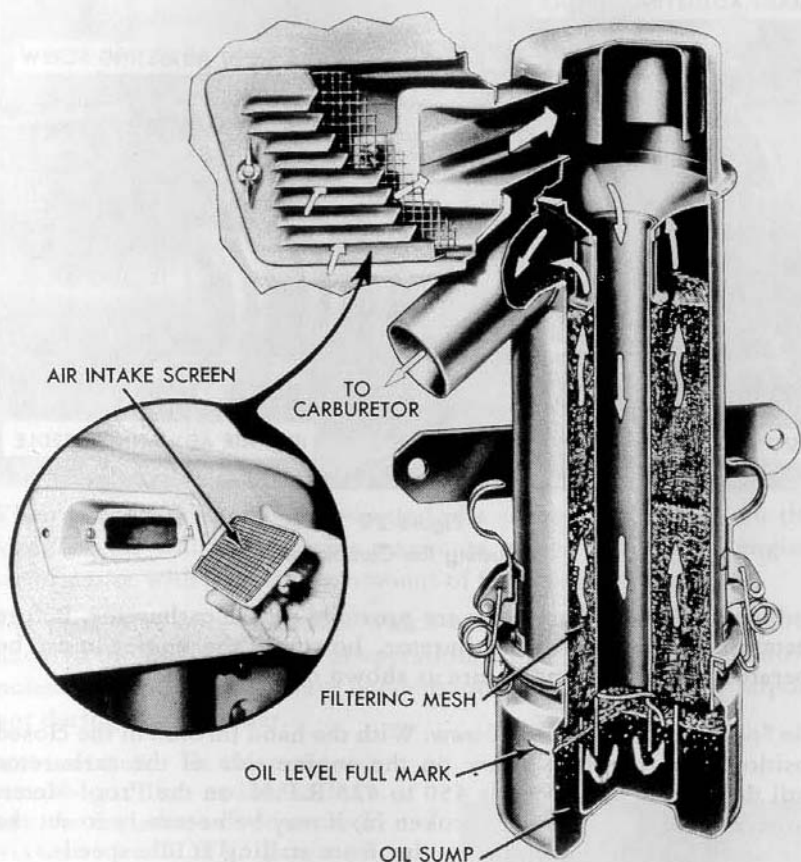

Figure 30
Sectional View of Carburetor Air Cleaner

Carburetor Air Cleaner: Regular service of the oil bath type air cleaner is extremely important in prolonging the engine life of your tractor. See the section on LUBRICATION, under Service Daily or Every Ten Hours, for proper servicing of the air cleaner. Figure 30 shows the passage of air through the intake screen, oil bath, filtering mesh and to the carburetor.

The installation of any accessory designed to further the filtering process serves no useful purpose and may result in increased fuel consumption and poor engine performance.

ELECTRICAL SYSTEM

Generator: The maximum charging rate of the generator is 20 amperes at 1650 engine R.P.M. The generator is driven by the fan belt. For adjustment, refer to "Water Pump and Fan Belt," under COOLING SYSTEM, page 35.

If the generator will not charge, check the condition of the wires in the generating circuit (Figure 31). Make sure all connections are clean and tight. If the wiring and connections are in good condition, check the generator and the regulator as follows:

Disconnect the field wire from the FIELD terminal of the regulator, then connect it to the ARM terminal. Start the tractor engine and observe the reading on the ammeter as the engine speed is increased. If the generator charge increases as the engine is speeded up, the regulator is at fault and must be replaced. If the generator charge does not increase, the generator is at fault and should be repaired or replaced.

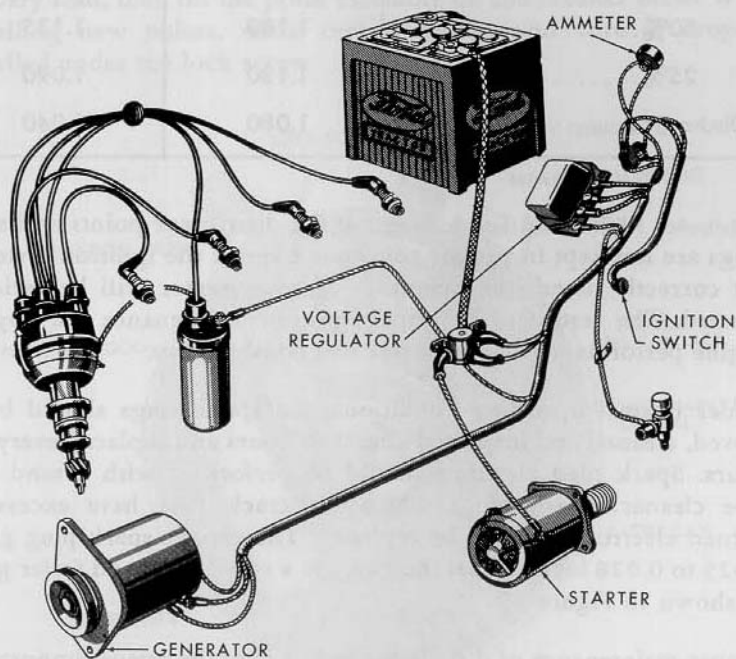

Figure 31
Generating System

Battery: The level of electrolyte in the battery should be checked at least twice monthly and distilled water added if necessary. Battery terminals should be kept tight and free of corrosion. Two tablespoons of baking soda mixed with a pint of water make a good solution for cleaning corroded terminals and the battery case. After cleaning, the battery should be washed with clean water. An application of petroleum jelly on the terminals will counteract corrosion.

Keep the battery fully charged at all times. The specific gravity of the electrolyte indicates the amount of battery charge. The amount of charge, with respect to specific gravity of the electrolyte, is shown in the following chart.

State of Charge	Specific Gravity Temperate Climates	Specific Gravity Tropical Climates
Fully Charged	1.280	1.225
75%	1.230	1.180
50%	1.180	1.135
25%	1.130	1.090
Discharged	1.080	1.040

Distributor Points and Spark Plugs: If the distributor points and spark plugs are not kept in proper adjustment and if the ignition system is not correctly timed, the operation of your tractor will be seriously affected. The results of improper ignition maintenance are sluggish engine performance and excessive fuel consumption.

Under normal operating conditions, the spark plugs should be removed, cleaned and inspected after 150 hours and replaced every 300 hours. Spark plug cleaning should be performed with a sand blast type cleaner. Spark plugs which are cracked or have excessively burned electrodes should be replaced. The proper spark plug gap is 0.025 to 0.028 inch. To set the gap, use a standard round feeler gauge as shown in Figure 32.

Proper maintenance of distributor points is of the utmost importance. Cleaning of the points, replacing when excessively worn, and the proper spacing are essential for peak efficiency.

To adjust the distributor points, remove the distributor cap. Crank the engine until the breaker arm rubbing block (see Figure 33) is resting on a high point of the distributor cam. Loosen the point assembly lock screws. Insert an adjusting tool or screwdriver in the adjustment slot and move the point assembly until the proper gap is established. The point spacing is 0.024 to 0.026 inch. Tighten the point assembly lock screws after making the adjustment.

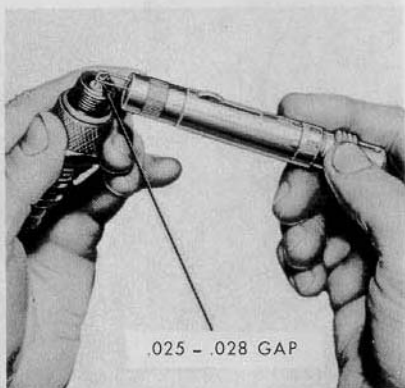

Figure 32
Checking Spark Plug Gap

To replace the points, remove the distributor cap. Remove the point assembly lock screws (Figure 33). Disconnect the condenser and primary lead, then lift the point assembly off the breaker plate. When installing new points, make certain the ground wire is properly installed under the lock screw.

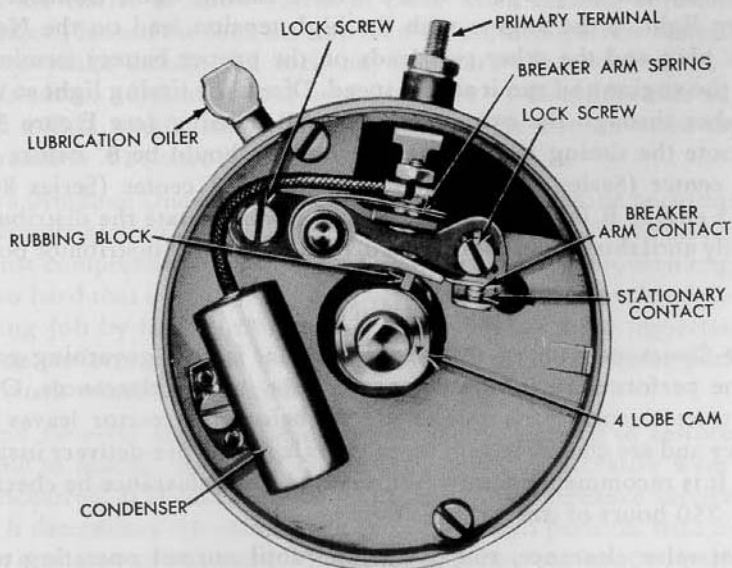

Figure 33
Distributor Assembly

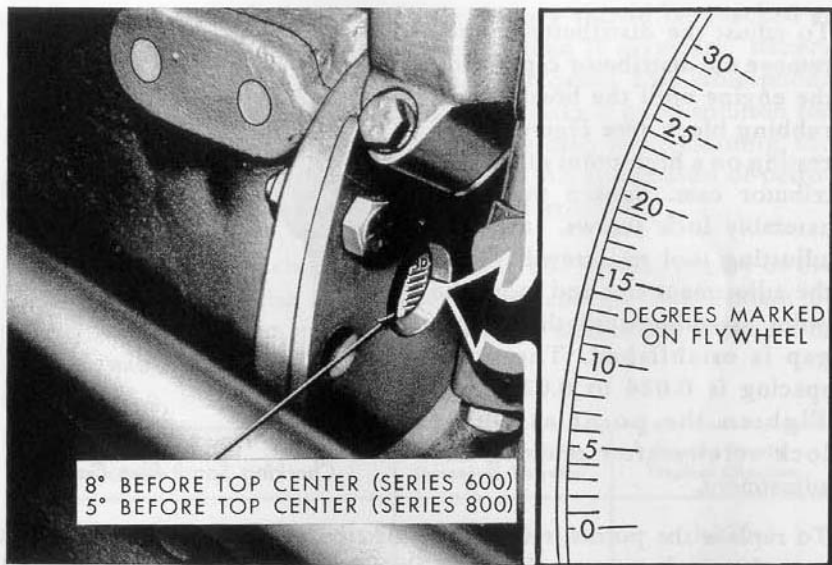

Figure 34
Basic Ignition Timing

Ignition Timing: When new distributor points are installed, the ignition system should be properly timed with a timing light. Connect the timing light to the engine with the high tension lead on the No. 1 spark plug and the other two leads on the proper battery terminals. Start the engine and run it at idle speed. Direct the timing light so that it flashes through the opening in the bell housing (see Figure 34), and note the timing marks. Ignition timing should be 8° before top dead center (Series 600) or 5° before top dead center (Series 800) at 475 engine R.P.M. Loosen the clamp screws, rotate the distributor slightly until this reading is obtained, then tighten the distributor body.

ENGINE

Valve Clearance: One of the most important factors governing good engine performance is that of correct valve tappet clearances. On a new tractor, correct clearances are set before the tractor leaves the factory and are checked again by your dealer at the pre-delivery inspection. It is recommended, however, that the valve clearance be checked every 250 hours of tractor operation.

To set valve clearance, run the engine until normal operating temperature is reached. Stop the engine, shut off the fuel supply, and remove the rocker shaft cover. Tappets can only be adjusted properly

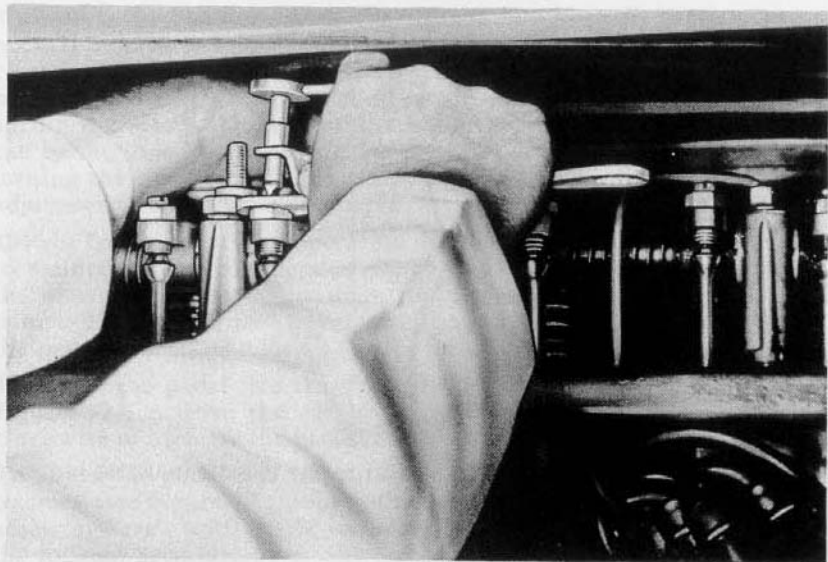

Figure 35
Valve Tappet Adjustment

when the valve is fully closed. It will be necessary to crank the engine with the starter to allow valves to close when making adjustments. To adjust, loosen the lock nut and turn the adjusting screw as desired. Always make certain the lock nut is secure after adjustment. The combination adjustment tool used in Figure 35 simplifies this adjustment and is obtainable from your dealer. The correct valve tappet clearance is .014 to .016 inch.

Valve Grinding: One of the factors involving good engine performance is absolute sealing of the combustion chamber by the valves and rings against compression losses. Valves and valve seats of modern engines are so hard that it is impossible to obtain a satisfactory valve reconditioning job by hand grinding. A good valve job is so important to engine performance that we recommend having your dealer perform this work whenever it becomes necessary.

Engine Tune-up: Engine tune-up procedure is intended to restore the engine to normal operating condition, providing excessive wear has not occurred. It is one of the most important maintenance services in that it determines whether or not the engine will perform with maximum economy and efficiency. Your dealer is best equipped to perform this service and advise as to the repairs or services necessary to restore the original performance of your tractor.

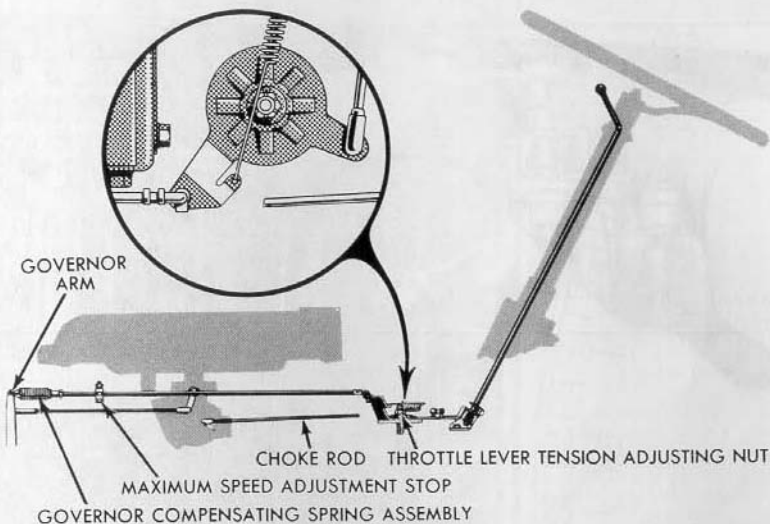

Figure 36
Governor and Control Linkage

Governor: Constant engine speed for any given throttle setting is controlled by the action of the adjustable centrifugal governor, located on the forward end of the crankshaft. As the engine speed is increased, the action of the governor moves the governor arm (see Figure 36) toward the closed carburetor throttle position until a balance between the spring tension and governor action is obtained. Maximum engine speed is controlled by the adjustable stop on the throttle rod, as shown.

Before attempting to set the engine governed speed, make certain the governor lever and carburetor throttle lever are both in the full open position. This can be checked by removing the throttle rod at the carburetor, and holding the throttle lever in open position as pulling force is applied to the throttle rod connected to the governor speed control arm. If the throttle rod connection will not slip over the ball on the carburetor throttle arm without moving the arm, the linkage must be adjusted. To do this, loosen the clevis lock nut and change the length of the rod as required.

Maximum governed engine speed must be set under no load conditions. After the tractor engine has been warmed up, set the idle speed at 450 to 475 revolutions per minute, then open the hand throttle to the wide open position. If the Proof-Meter registers 2200 R.P.M. on Series 600 tractors and 2400 R.P.M. on Series 800 tractors, the governor is properly set. If adjustment is necessary, reposition the maximum speed adjustment stop as required.

Throttle Lever Position: After the tractor has been in service, some normal linkage wear occurs. The hand throttle lever may creep toward closed position when driving the tractor over rough ground. The fixed position of this lever is controlled by the tension applied by the spider spring washer on the bell crank, as shown in Figure 36. This tension can be increased by removing the cotter pin in the castellated nut and turning the nut clockwise until the desired tension is obtained. After adjustment, reinstall the cotter pin.

Clutch: To obtain proper operation of the engine clutch, it is necessary to maintain the recommended clutch pedal free travel. Free travel is the distance the clutch pedal can be pushed down before resistance is met. The correct free pedal travel is $\frac{3}{4}$ of an inch, as measured at the pedal pad.

To adjust the pedal free travel on the Model 640 tractor (see *insert*, Figure 37), remove the clevis pin and turn the eye bolt counterclockwise to increase the pedal free travel to the required $\frac{3}{4}$ of an inch.

To adjust the pedal free travel on the Model 650, 660, 850 and 860 tractors (see Figure 37), loosen the locknut, turn the pedal free travel adjusting screw until the $\frac{3}{4}$ inch free travel is obtained, then retighten the locknut securely.

On Model 660 and 860 tractors equipped with the double clutch for live P.T.O. operation, the pedal is normally set at a height of 10 inches from the running board. However, the pedal can be set for operation of the transmission clutch only, by shifting the clevis pin to the front hole in the clevis. See Figure 37.

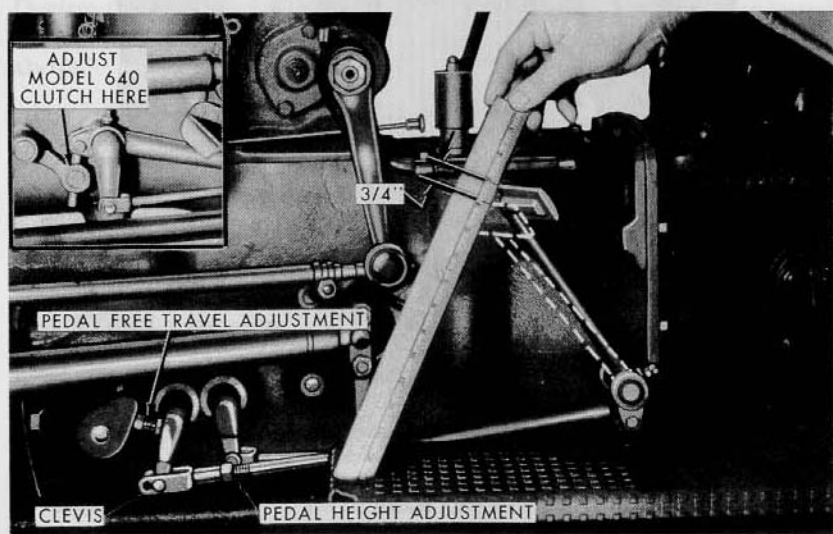

Figure 37
Clutch Pedal Free Travel Adjustment

WHEELS, BRAKES AND TIRES

Front Wheel Toe-in: Front wheel toe-in is set at the factory with precision equipment. The spindles and spindle arms are then chisel marked at the points shown in Figure 38. To align the chisel marks, loosen the clamps at each end of the drag links and adjust as required.

When setting the wheels at the wide position, or when replacing spindles, it will be necessary to realign the wheels. This is done by measuring between the outside of the tire ribs at hub height on both the front and rear of the wheels. Adjust the drag links until the correct toe-in of $\frac{1}{8}$ to $\frac{1}{2}$ inch is obtained.

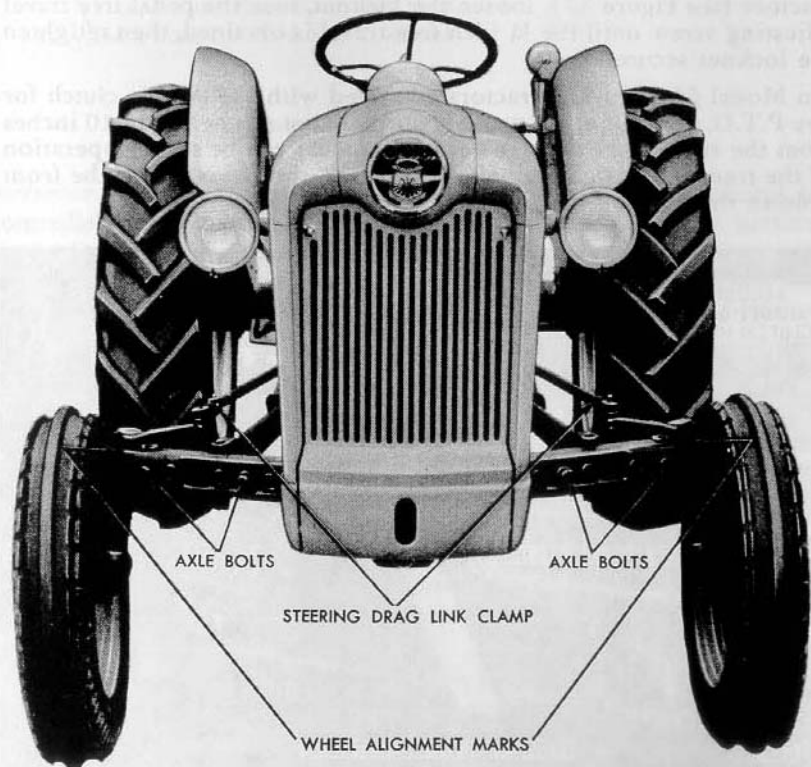

Figure 38
Front Wheel Toe-in Adjustment

Front Wheel Bearings: To adjust the front wheel bearings, raise the front of the tractor with your tractor jack until the wheels rotate freely. Remove the hub cap and the cotter pin which holds the castellated nut and turn the nut until a slight drag is felt. Then back off the nut until the nearest slot in the nut is aligned with the hole in the spindle. Reinstall the cotter pin and hub cap. Pack the bearings with short fibre grease every 600 hours of operation as directed under LUBRICATION, page 31.

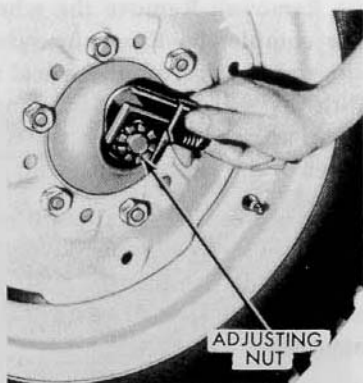

Figure 39
Adjusting Front Wheel Bearings

Brake Adjustment: Jack the tractor up until both rear wheels are free. Remove the adjusting slot cover from the back plate and, with the brake pedals released, turn the adjusting screw clockwise until the brake drags. (See Figures 40 and 41.) Back off the adjusting screw until the wheel turns just free of brake drag. Adjust the left brake tie rod with the clevis until both brake pedals are in line when both brakes are engaged.

During the first hour of operation after the brakes have been adjusted, check the drums for overheating. If necessary, readjust as outlined above.

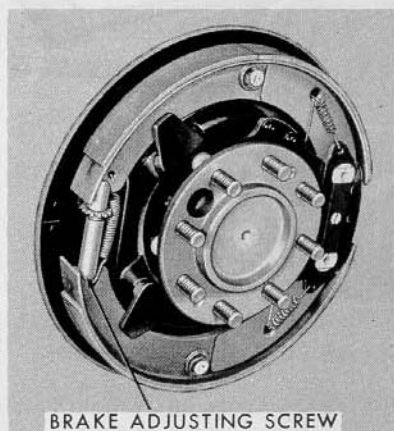

Figure 40
Brake Assembly with Drum Removed

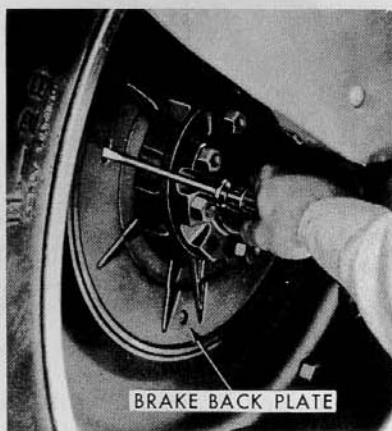

Figure 41
Adjusting the Brakes

Tire Removal: Remove the wheel from the hub and deflate the inner tube completely. Press the valve through the valve hole and loosen both tire beads from the wheel rim, using a tire iron and heavy mallet. With the wheel lying flat, stand on the tire with your feet about 15 inches apart opposite the valve, then force the bead seat into the drop center of the rim.

Insert two tire irons, about 8 inches apart, between the tire bead and the wheel rim near the valve, then pry the bead over the wheel rim. Leaving one tire iron in position, follow around the wheel rim with the other tire iron to remove the remainder of the bead. Remove the inner tube.

Turn the wheel over and block up the disc until the rim is off the floor, as shown in Figure 43. Pry the tire off the rim, starting with a small section and following around the wheel.

Tire Installation: Place the wheel and rim in a flat position. Inflate the inner tube until it is barely rounded out, then install the tube in the tire.

Coat the inside and outside of the tire beads with a soft soap and water solution to protect the bead, then pry the bead over the edge of the rim.

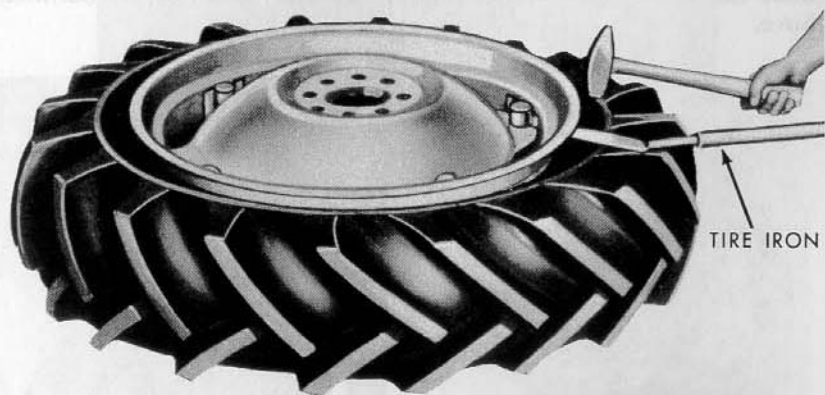

Figure 42
Loosening Tire Bead from Edge of Rim

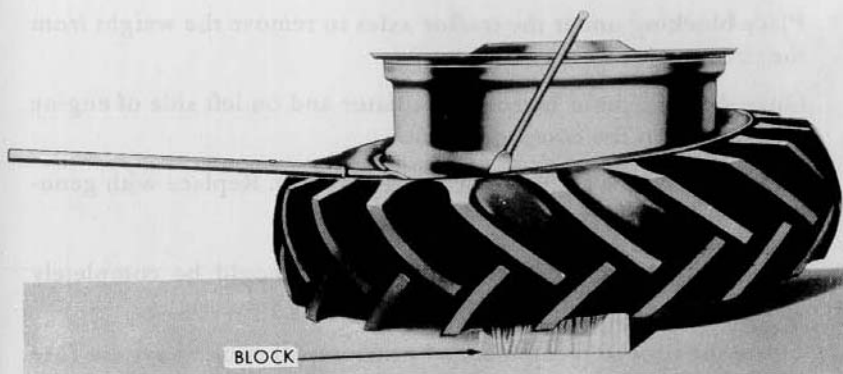

Figure 43
Prying Rim Out of Tire

TRACTOR STORAGE

Tractors which are used seasonally should be protected while in storage.

The following operations are suggested:

1. Wash and clean the tractor thoroughly.
2. Use Dearborn Sprayon Touch-Up Enamel where necessary to avoid rust.
3. Block the clutch in the released position.
4. Lubricate the tractor, drain and refill transmission, differential, hydraulic system, and engine, as directed under LUBRICATION. Use engine preservative oil in the crankcase to prevent internal corrosion.
5. Drain the fuel tank and sediment bowl, then run the engine until the gasoline supply in the carburetor is exhausted.
6. Remove the spark plugs and pour three ounces of engine preservative oil into each cylinder. Turn the engine several revolutions with the starter, then replace the spark plugs. This will coat the combustion chamber with an oil film.

7. Remove the battery and be sure it is fully charged before placing it in storage in a warm place.
8. Place blocking under the tractor axles to remove the weight from the tires.
9. Open drain cocks at bottom of radiator and on left side of engine block to drain the cooling system.
10. Check the tractor for worn or damaged parts. Replace with genuine Ford Tractor parts.

Tractors which have been placed in storage should be completely serviced in the following manner before putting into use.

1. Inflate the tires to recommended pressure; fill cooling system (use corrosion inhibitor in warm weather, anti-freeze in winter), fill gasoline tank with fuel; check oil level in crankcase, rear end, transmission, and air cleaner, and install fully charged battery.
2. Start the engine and let it idle a few minutes. Be sure the engine is receiving lubrication and that each control is functioning correctly.
3. Drive the tractor without a load to be sure it is operating satisfactorily.





ACCESSORIES

A wide variety of accessories, attachments and special items are available for use on your new Ford Tractor.

These are designed to make your farm work easier by providing you with maximum convenience and operating comfort. In many cases, they will improve the performance of your Ford Tractor and Dearborn Equipment.

All of the accessories, attachments and special items described in this section are available, at extra cost, from your local Ford Tractor and Implement Dealer.

ACCESSORIES

REST-O-RIDE TRACTOR SEAT

(STANDARD ON SERIES 800 TRACTORS)

Special torsional rubber springs in the Rest-O-Ride Seat provide maximum comfort and safety. The seat is easily adjusted to fit the weight of nearly any operator, and can be tilted back to permit stand-up driving.

BUMPER

This heavy, welded and riveted steel bumper protects the radiator grille and permits pushing or pulling with the front of the tractor. The bumper is easily installed by bolting to the front axle.

SELEC-TROL VALVE

This attachment, conveniently located under the tractor seat, permits you to direct the flow of hydraulic power from the hydraulic system to remote cylinders, such as those on loaders and auxiliary equipment. By merely changing the position of the Selec-Trol knob, rear mounted implements can be used alternately with the Dearborn Standard Loader.

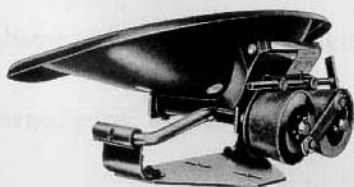

Figure 44
Tractor Seat

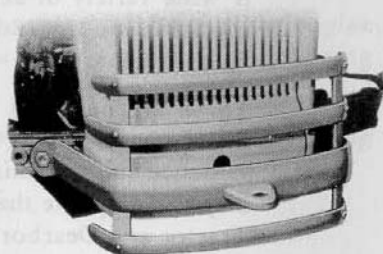

Figure 45
Bumper

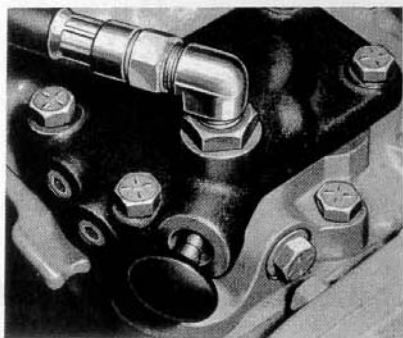

Figure 46
Selec-Trol Valve

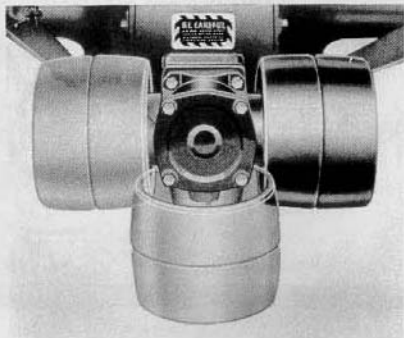

Figure 47
Power Take-Off Pulley Assembly

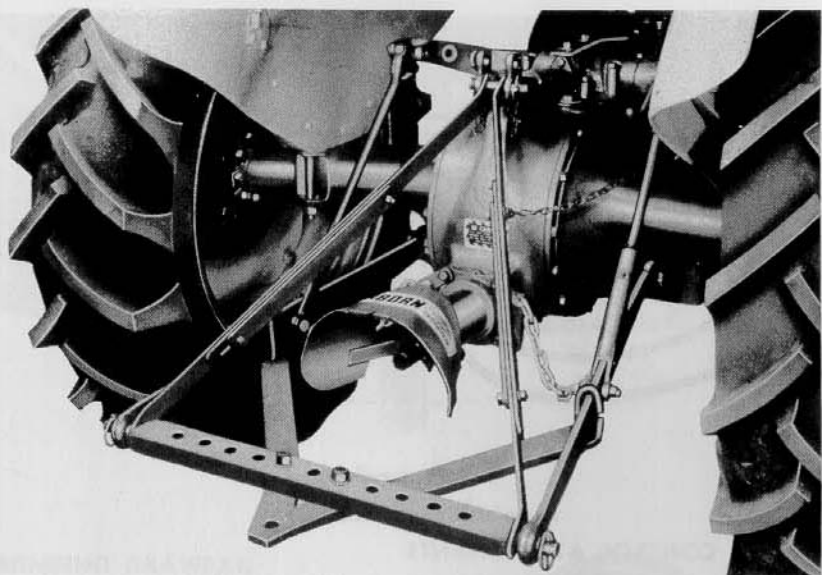

Figure 48
A.S.A.E. PTO Conversion Assembly

POWER TAKE-OFF PULLEY ASSEMBLY

The unit is easily attached so that the pulley works in the right, left or down position. It may be used to drive many different belt driven implements. Refer to page 21 for Belt Pulley operation.

A.S.A.E. PTO CONVERSION ASSEMBLY

This attachment converts the Ford Tractor PTO to A.S.A.E. standards. The assembly includes a PTO extension, safety shield, drawbar extension and drawbar stay braces.

GREASE GUN AND BRACKET

This sturdily constructed, rust resistant grease gun is ideal for lubricating tractors and implements, as well as other vehicles or farm equipment having high pressure type fittings. A matching bracket for attaching the gun to the tractor fender is sold separately.

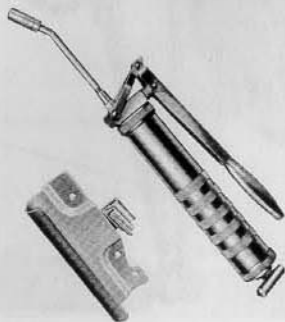

Figure 49
Grease Gun and Bracket

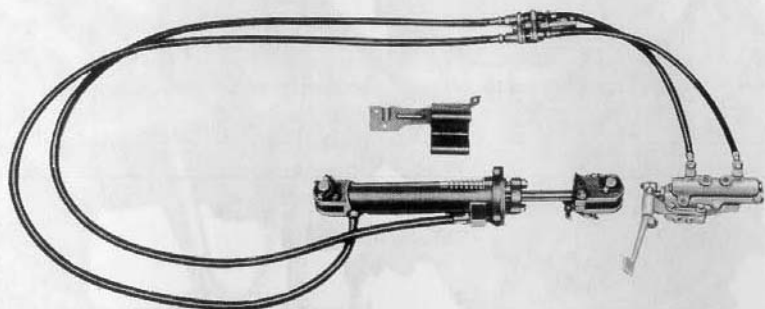

Figure 50
Remote Control Attachments

REMOTE CONTROL ATTACHMENTS

These attachments consist of the Control Valve and the Remote Control Cylinder. By simply moving the valve, you can set or adjust many pull-type implements, or do other odd jobs around the farm. Break-away hose couplings facilitate attaching and detaching.

STABILIZER LINK KIT

For certain operations such as middle-busting and planting, stabilizer bars will eliminate side sway and keep the implement in a straight line with the tractor. The bars do not affect the action of the tractor hydraulic system.

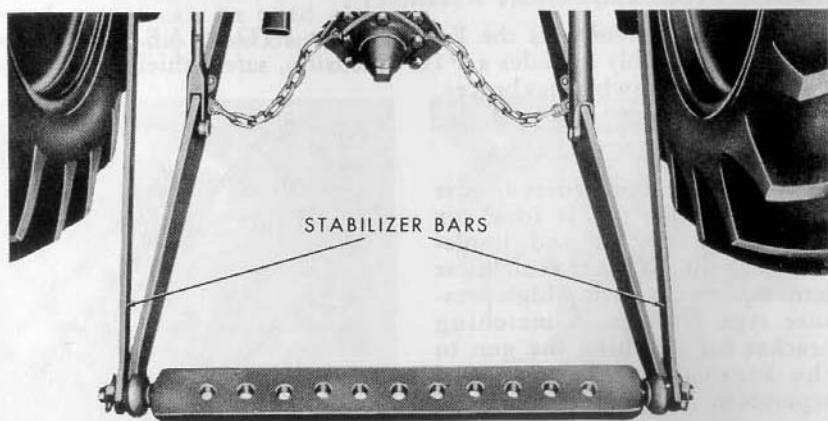

Figure 51
Stabilizer Assembly

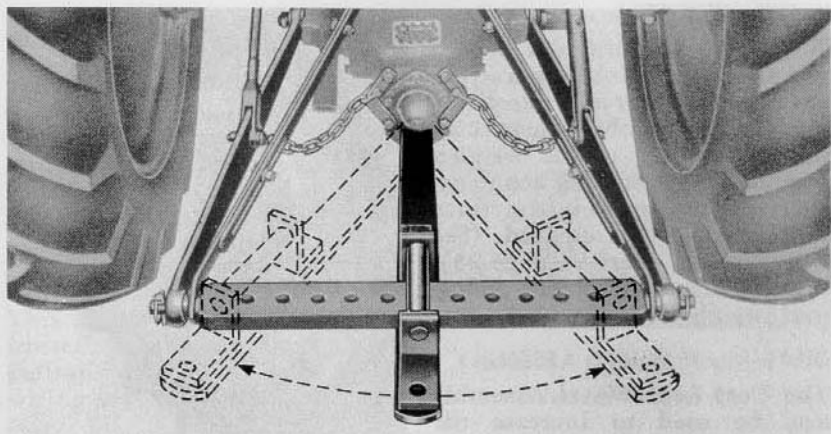

Figure 52
Swinging Drawbar

SWINGING DRAWBAR

The sturdily built Swinging Drawbar is made of high carbon steel with a heat treated roller for greater strength and longer life. The drawbar is easily attached or detached by means of a clevis (extra equipment), and swings 60 degrees from one end to the other of the regular Ford Tractor Drawbar.

TIRE PUMP AND GAUGE

The flexible 16 foot hose reaches all four tractor tires easily, and can be used for pumping up implement, automobile or truck tires. Just remove one spark plug from the tractor engine and insert the brass hose connections on the tire pump. While the engine idles, a dependable gauge registers air pressure in the tires.

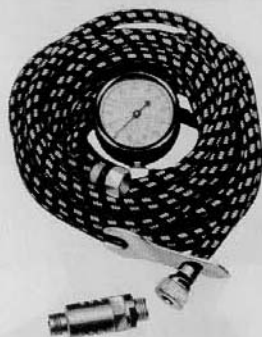

Figure 53
Tire Pump and Gauge

CIGARETTE LIGHTER

In wet or windy weather, it's safer and easier to light a cigarette with the Ford Tractor Cigarette Lighter. This inexpensive kit is easily installed on your tractor.

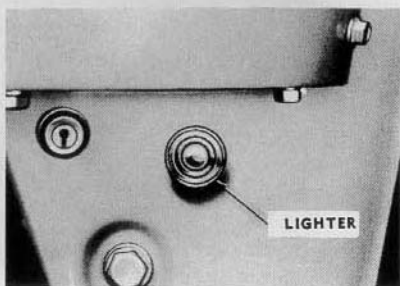

Figure 54
Cigarette Lighter

WHEEL WEIGHTS

With easy-on, easy-off wheel weights, you can have the traction you need for heavy jobs like plowing. On lighter jobs such as cultivating, removal of the weights will increase operating economy. Twelve individual weight sections can be added, as required. (See wheel weight chart on page 25). Front wheel weights and industrial weights are also available.

DUAL REAR WHEEL ASSEMBLY

The Dual Rear Wheel Assembly may be used to increase the weight and traction of the rear wheels when operating with front mounted loaders. It will also improve flotation in light, sandy soils.

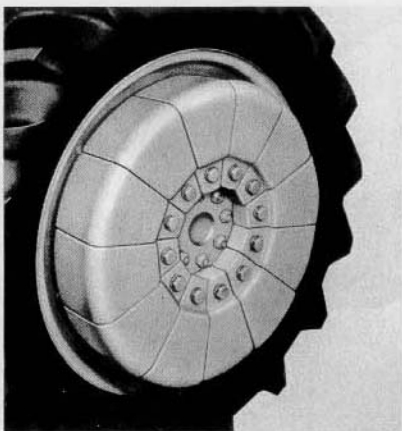

Figure 55
Wheel Weights
(Heavy Duty)

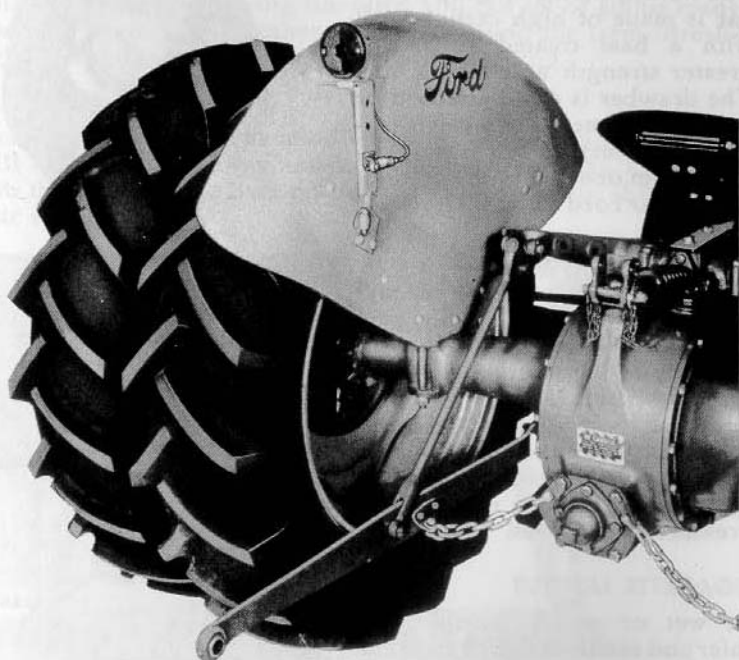

Figure 56
Dual Rear Wheel Assy.

VERTICAL EXHAUST KIT

Use the Vertical Exhaust Kit for operations where there might be danger of igniting the crop with a conventional exhaust pipe. This kit also permits operation in rough fields where conventional tail pipes might be bent or damaged.

IMPLEMENT LAMP KIT

This kit includes a sealed beam, frosted, flood type lamp with a built-in switch and the necessary wiring and brackets.

FORD TRACTOR SPARK PLUGS

To get top engine performance with maximum economy, old spark plugs should be replaced with new ones after every 300 hours of operation. Keep an extra set of Ford Tractor Spark Plugs on hand at all times.

FORD TRACTOR BATTERY

Buy the Ford "Tractor-tested" Battery, designed especially for rough, farm use. This 80 amp. hour battery is famous for quick starts, long life, and its liberal guarantee.

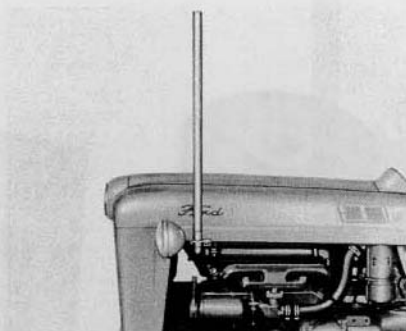

Figure 57
Vertical Exhaust Kit

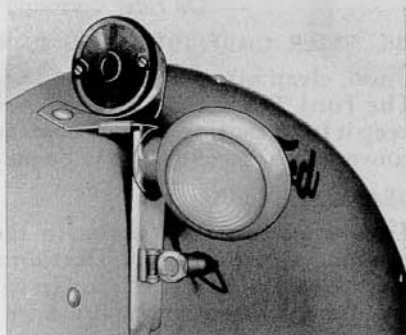

Figure 58
Implement Lamp Kit

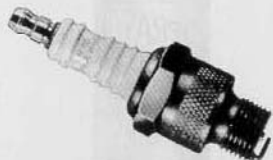

Figure 59
Ford Tractor Spark Plugs



Figure 60
Ford Tractor Battery



Figure 61
Oil Filter Cartridge and Cartridge Pack

OIL FILTER CARTRIDGE AND CARTRIDGE PACK

Good, clean oil is essential to proper operation and long engine life. The Ford Tractor Oil Filter Cartridge will catch foreign matter and keep it from causing serious damage to precision engine parts. For your convenience, cartridges may be purchased in packs of three, as shown.

DEARBORN ENAMEL

To prevent rust and maintain the appearance of your tractor and equipment, use genuine Dearborn Enamel. This high quality, synthetic enamel is available in Grey, Medium Grey and Vermillion, and may be applied either by brush or spray gun.

DEARBORN SPRAYON TOUCH-UP ENAMEL

For a quick "touch-up" job on your tractor and equipment, use a handy can of Dearborn Sprayon Enamel. Just shake the can and push the button to apply an even coat of protective enamel.



Figure 62
Dearborn Enamel



Figure 63
Dearborn Sprayon Touch-up Enamel



SPECIFICATIONS

SPECIFICATIONS*

SERIES 600 & 800

GENERAL

Wheelbase.....	75.2 inches
Over-all Length.....	Series 600—121.4 inches Series 800—121.8 inches
Over-all Width.....	64.75 inches
Front Tread Width.....	52 to 76 inches
Rear Tread Width.....	52 to 76 inches
Crop Clearance.....	21 inches
Turning Circle Diameter (with brakes).....	18 feet
Shipping Weight.....	Series 600—2750 lbs. (approx.) Series 800—2850 lbs. (approx.)
Tire Size:	
Front—Standard.....	Series 600—5:50 x 16—4 ply Series 800—6:00 x 16—4 ply
Rear—Standard.....	Series 600—11:00 x 28—4 ply Series 800—12:00 x 28—4 ply

CAPACITIES

Fuel Tank.....	Series 600—11 U.S. gallons (8.8 Imperial gals.) Series 800—14 U.S. gallons (11.2 Imperial gals.)
Cooling System.....	15 U.S. quarts (12 Imperial qts.)
Crankcase (including filter).....	5 U.S. quarts (4 Imperial qts.)
Transmission.....	4 Speed—6½ U. S. quarts (5.2 Imperial qts.) 5 Speed—7½ U. S. quarts (6 Imperial qts.)
Hydraulic Reservoir.....	9 U.S. quarts (7.2 Imperial qts.)
Differential.....	Series 600— 8½ U. S. quarts (6.8 Imperial qts.) Series 800—11½ U. S. quarts (9.2 Imperial qts.)
Steering Gear Housing.....	1½ pounds

ENGINE

Type.....	4 cylinder, in-line, overhead valve
Bore.....	Series 600—3.44 inches Series 800—3.90 inches
Stroke.....	3.60 inches
Displacement.....	Series 600—134 cu. inches Series 800—172 cu. inches
Compression Ratio.....	Series 600—6.60 to 1 Series 800—6.75 to 1
Firing Order.....	1-2-4-3
Idle Speed.....	450-475 R.P.M.
Maximum Speed (no load).....	Series 600—2200 R.P.M. Series 800—2400 R.P.M.
Sleeves.....	Cast iron, dry type
Pistons.....	Aluminum alloy
Tappet Clearance (intake and exhaust—hot).....	.014 to .016 inch
Governor.....	Variable speed, centrifugal flyball type

COOLING SYSTEM

Type.....	Pressure
Fan.....	Three blade
Thermostat.....	Starts to open—157 to 162° F. Fully open—177 to 182° F.

FUEL SYSTEM

Type.....	Gravity flow
Carburetor.....	Single up-draft
Idle Fuel Adjustment.....	One turn—open
Main Fuel Jet Adjustment.....	One and one-quarter turns

IGNITION SYSTEM

Type.....	Dist.—automatic centrifugal spark advance
Initial Timing.....	Series 600—8 degrees B.T.D.C. at 475 R.P.M. Series 800—5 degrees B.T.D.C. at 475 R.P.M.
Advance at 2000 R.P.M.....	Series 600—29 to 31 degrees Series 800—26 to 28 degrees
Distributor Point Spacing.....	.024 to .026
Spark Plug Size.....	14 MM
Spark Plug Gap.....	.025—.028

ELECTRICAL SYSTEM

Generator.....	Two brush shunt wound
Capacity.....	20 amps., 140 watts
Generator Regulator.....	Relay type
Battery.....	6 volt—80 ampere hours
Terminal Grounded.....	Positive
Starter Motor.....	Automatic, with safety switch 6 volt—follow through

CLUTCH

Type.....	Model 640—Single plate, 9 inch Model 650—Single plate, 10 inch Model 660—Double plate, 9 inch Model 850—Single plate, 10 inch Model 860—Double plate, 9 inch
-----------	--

TRANSMISSION

Type.....	Model 640—Constant mesh, 4 speed, helical gear
Gear Ratios:	
First Gear.....	11.00 to 1
Second Gear.....	8.55 to 1
Third Gear.....	6.21 to 1
Fourth Gear.....	2.98 to 1
Reverse Gear.....	10.04 to 1
Type.....	Models 650, 660, 850, 860—Constant mesh, 5 speed, helical gear
Gear Ratios:	
First Gear.....	17.54 to 1
Second Gear.....	11.04 to 1
Third Gear.....	8.31 to 1
Fourth Gear.....	6.02 to 1
Fifth Gear.....	2.76 to 1
Reverse Gear.....	10.29 to 1

HYDRAULIC SYSTEM

Type.....	Live action
Maximum Pressure.....	2000 lbs. p.s.i.
Pump:	
Type.....	Vane
Drive.....	Gear
Capacity.....	4 to 4.8 G.P.M. at 2000 R.P.M.
Control.....	Implement position or constant draft

REAR AXLE

Type.....	Semi-floating
Ratio.....	Series 600—6.66 to 1 Series 800—7.17 to 1

BRAKES

Type.....	Internal expanding
Control.....	Mechanical
Width.....	1½ inch
Drum Size.....	14 inch diameter
Pedal Free Travel.....	¾ inch

AMERICAN PETROLEUM INSTITUTE OIL CLASSIFICATION

NEW TYPE	WHEN TO USE	OLD TYPE
ML	Light and Favorable Conditions: Light or normal operation. This includes average loads with no severe high or low temperature conditions.	Regular
MM	Moderate to Severe Conditions: Moderate to severe operation. This includes heavy loads and most temperature conditions.	Premium
MS	Unfavorable or Severe Conditions: This type of operation includes the most severe loads and temperature variation. Operation during winter months promotes condensation, oil dilution and sludge formation. High temperature, heavy-load service promotes oxidation of the lubrication oil and may cause high-temperature varnish and sludge deposits.	Heavy Duty

*The Ford Motor Company reserves the right to make changes in specifications or to add improvements at any time without notice or obligation.

CONTENTS

	PAGE
TRACTOR SERVICE POLICY.....	2
FOREWORD.....	3
TRACTOR MODEL AND SERIAL NUMBER.....	4
CONTROLS AND INSTRUMENTS.....	5
Tractor Seat.....	6
Light Switch.....	6
Ignition Switch.....	6
Choke Control.....	7
Starter Button.....	7
Throttle Control.....	7
Oil Pressure Gauge.....	8
Temperature Gauge.....	8
Ammeter.....	8
Clutch Pedal.....	8
Brake Pedals.....	8
Brake Pedal Locks.....	9
Power Take-Off Lever.....	9
Hydraulic Touch Control Lever.....	9
Constant Draft—Position Control Lever.....	9
Fuel Shut-Off Valve.....	10
Proof-Meter.....	10
OPERATION.....	13
Pre-Starting Check.....	14
Break-In Procedure.....	14
Starting the Engine.....	15
Operating the Tractor.....	15
Operating the Hydraulic System.....	16
Implement Position Control.....	16
Constant Draft Control.....	17
Hy-Trol Valve.....	17
Attaching Implements.....	18
Two Hole Hydraulic Lift Rocker.....	18
Adjustable Top Link.....	19
Drawbar Stays.....	19
Power Take-Off Operation.....	20
Power Take-Off Conversion Kit.....	20
Belt Pulley.....	21
Wheel Tread Adjustments.....	22
Front Wheel Tread Adjustments.....	22
Rear Wheel Tread Adjustments.....	23
Wheel Weight.....	24
MAINTENANCE.....	27
Pre-Delivery Inspection.....	28
50 Hour Inspection.....	28
Lubrication.....	28
Service Daily or Every Ten Hours.....	28
Service Every 100 Hours.....	30

Service Every 200 Hours.....	30
Service Every 600 Hours.....	31
Lubrication Chart.....	32, 33
Mechanical Maintenance.....	34
Cooling System.....	34
Fuel System.....	36
Electrical System.....	39
Engine.....	42
Wheels, Brakes and Tires.....	46
Tractor Storage.....	49
ACCESSORIES.....	51
Rest-O-Ride Tractor Seat.....	52
Bumper.....	52
Selec-Trol Valve.....	52
Power Take-Off Pulley Assembly.....	53
A.S.A.E. PTO Conversion Assembly.....	53
Grease Gun and Bracket.....	53
Remote Control Attachments.....	54
Stabilizer Link Kit.....	54
Swinging Drawbar.....	55
Tire Pump and Gauge.....	55
Cigarette Lighter.....	55
Wheel Weights.....	56
Dual Rear Wheel Assembly.....	56
Vertical Exhaust Kit.....	57
Implement Lamp Kit.....	57
Ford Tractor Spark Plugs.....	57
Ford Tractor Battery.....	57
Oil Filter Cartridge and Cartridge Pack.....	58
Dearborn Enamel.....	58
Dearborn Sprayon Touch-up Enamel.....	58
SPECIFICATIONS.....	59
General.....	60
Capacities.....	60
Engine.....	60
Cooling System.....	61
Fuel System.....	61
Ignition System.....	61
Electrical System.....	61
Clutch.....	61
Transmission.....	61
Hydraulic System.....	62
Rear Axle.....	62
Brakes.....	62
American Petroleum Institute Oil Classification.....	62

